



SUBARU

Informationen für Rettungsdienste

Bitte beachten Sie:

Die in den einzelnen Rettungskarten geschilderten Angaben sind ausschließlich für die Nutzung durch Rettungsdienste zusammengestellt und nicht für die herkömmliche Arbeit an Fahrzeugen gedacht. SUBARU Kunden finden detaillierte Sicherheitshinweise zu den Funktionen Ihres Fahrzeuges in der Bedienungsanleitung. Werkstätten und Händler erhalten Reparaturhandbücher durch die von uns bekanntgegebenen Bezugsquellen.



Rettungskarten

Justy

Justy

Typ M3

ab MJ 2008



Impreza

Impreza

Typ G3

ab MJ 2008



XV

XV

Typ G4

2012-017



Impreza

Impreza

I

Typ G4

2012-017



Impreza & XV

Impreza & XV

Typ G5

ab MJ 2018



Forester

Forester

Typ SH/SHS

ab MJ 2009



Forester

Typ SJ

ab MJ 2013



Legacy

Legacy Limousine

Typ BL/BP BL/BPS

2004-2009



Legacy Kombi

Typ BL/BP BL/BPS

2004-2009



Legacy Limousine

Typ BM/BR BM/BRS

2010-2014





Legacy Kombi

Typ BM/BR BM/BRS

2010-2014



Outback
Outback

Typ BL/BP BL/BPS

2004-2009



Outback

Typ BM/BR BM/BRS

2010-2014



Outback

Typ BSD/BS9

ab MJ 2015



Outback

Typ B7/BT9

ab MJ 2021



Tribeca
Tribeca

Typ WX

ab MJ 2008



WRX STi
Impreza STi

Typ G3

ab MJ 2010



WRX STi
Impreza STi

Typ V1

ab MJ 2015



BRZ
BRZ

Typ ZC

ab MJ 2013



BRZ

Ab MJ 2023



Levorg
Levorg

Typ VM

ab MJ 2016





Rettungskarten für Fahrzeuge mit Autogasanlage

Impreza
Impreza

Typ G3

ab MJ 2008



Forester
Forester

Typ SH/SHS

ab MJ 2009



Legacy
Legacy Limousine

Typ BL/BP BL/BPS

2004-2009



Legacy Kombi

Typ BL/BP BL/BPS

2004-2009



Legacy Limousine

Typ BM/BR BM/BRS

ab MJ 2010



Legacy Kombi

Typ BM/BR BM/BRS

ab MJ 2010



Outback
Outback

Typ BL/BP BL/BPS

2004-2009



Outback

Typ BM/BR BM/BRS

ab MJ 2010





Rettungskarten für Fahrzeuge mit Hybridantrieb

Forester

Forester



Typ S5

ab MJ 2020



Impreza & XV

Impreza & XV



Typ G5

ab MJ 2020



Rettungskarten für Fahrzeuge mit Batterieelektrischem Antrieb

Solterra

Solterra



Typ EAM1S(M)

ab MJ 2023





Wie sollten sich Rettungskräfte verhalten, wenn die Airbags im Unfallfahrzeug nicht gezündet haben?

- Zündung ausschalten.
- Beide Batteriekabel abklemmen oder durchtrennen.
- Beschädigungen der Airbag-Module im Lenkrad oder Armaturenbrett (z. B. durch Schneiden oder Bohren) vermeiden.
- Hitzeeinwirkung im Bereich des Lenkrades und der Armaturenbrettabdeckung vor dem Beifahrersitz vermeiden. Eine Temperatur von ca. 200 ° C am Gasgenerator führt zur Auslösung des Airbags, auch wenn die Batterie abgeklemmt wurde.
- Werden bei Rettungsarbeiten einzelne Fahrzeugteile bewegt oder elektr. Leitungen durchtrennt, ist eine Airbag-Auslösung nicht auszuschließen. Daher bei Rettungsarbeiten im Bereich Fahrer- Beifahrersitz größte Vorsicht anwenden! Kopf und Oberkörper nicht in den Wirkungsbereich des Airbags bringen.
- Beim SUBARU Justy Modelljahr 1996 erfolgt die Auslösung des Airbags rein mechanisch. Achtung! Bei diesen Fahrzeugen hat das Abklemmen der Batterie keine Wirkung. Hier ist es wichtig Lenksäule / Lenkrad schonend zu behandeln, da hier der Sensor angebracht ist.

Geht von den nicht ausgelösten Airbags überhaupt eine Gefahr aus?







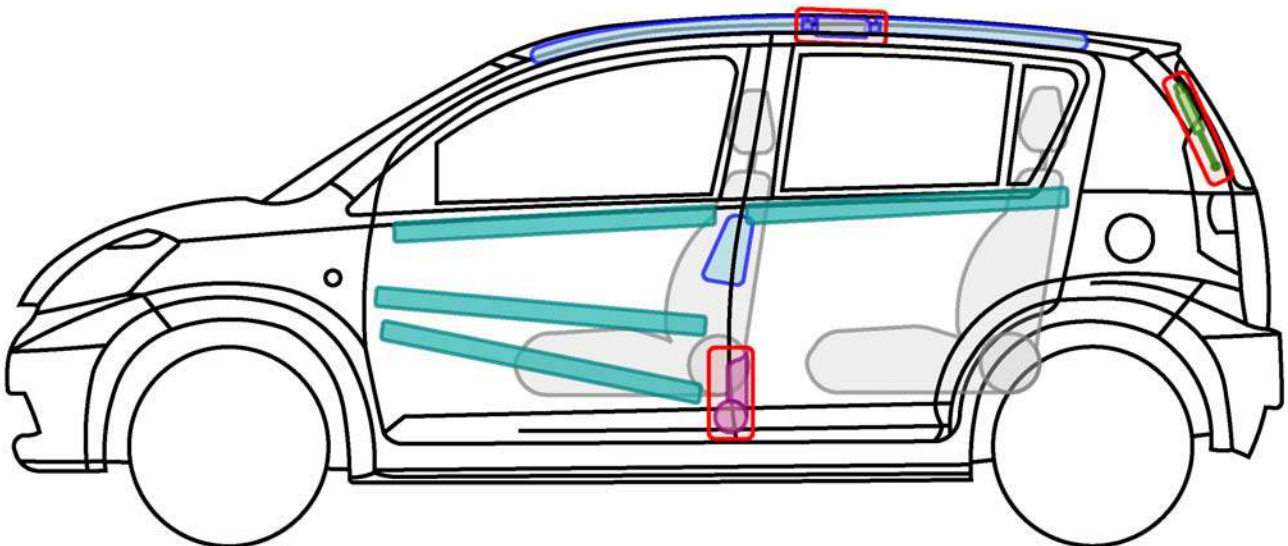
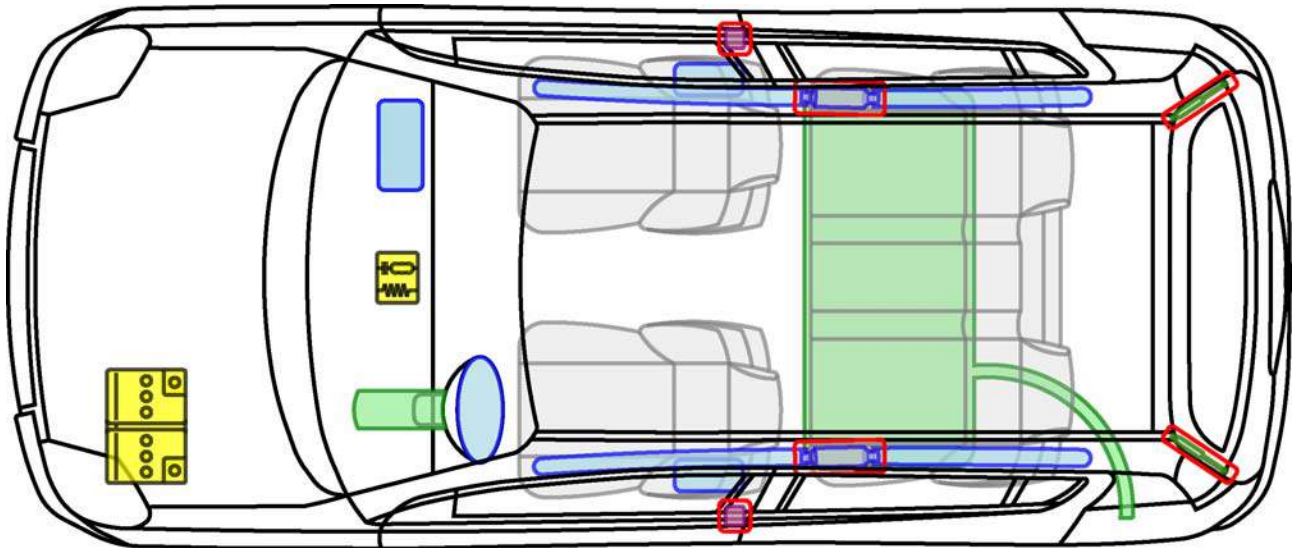

Ja! Daher oben beschriebene Vorgehensweise einhalten.

Wird diese Gefahr gegebenenfalls durch Sitzbelegungserkennungen vermindert?

SUBARU-Fahrzeuge sind zur Zeit mit diesen Systemen nicht ausgestattet.

SUBARU: Justy
 Typ: M3
 Karosserievariante ab 2008









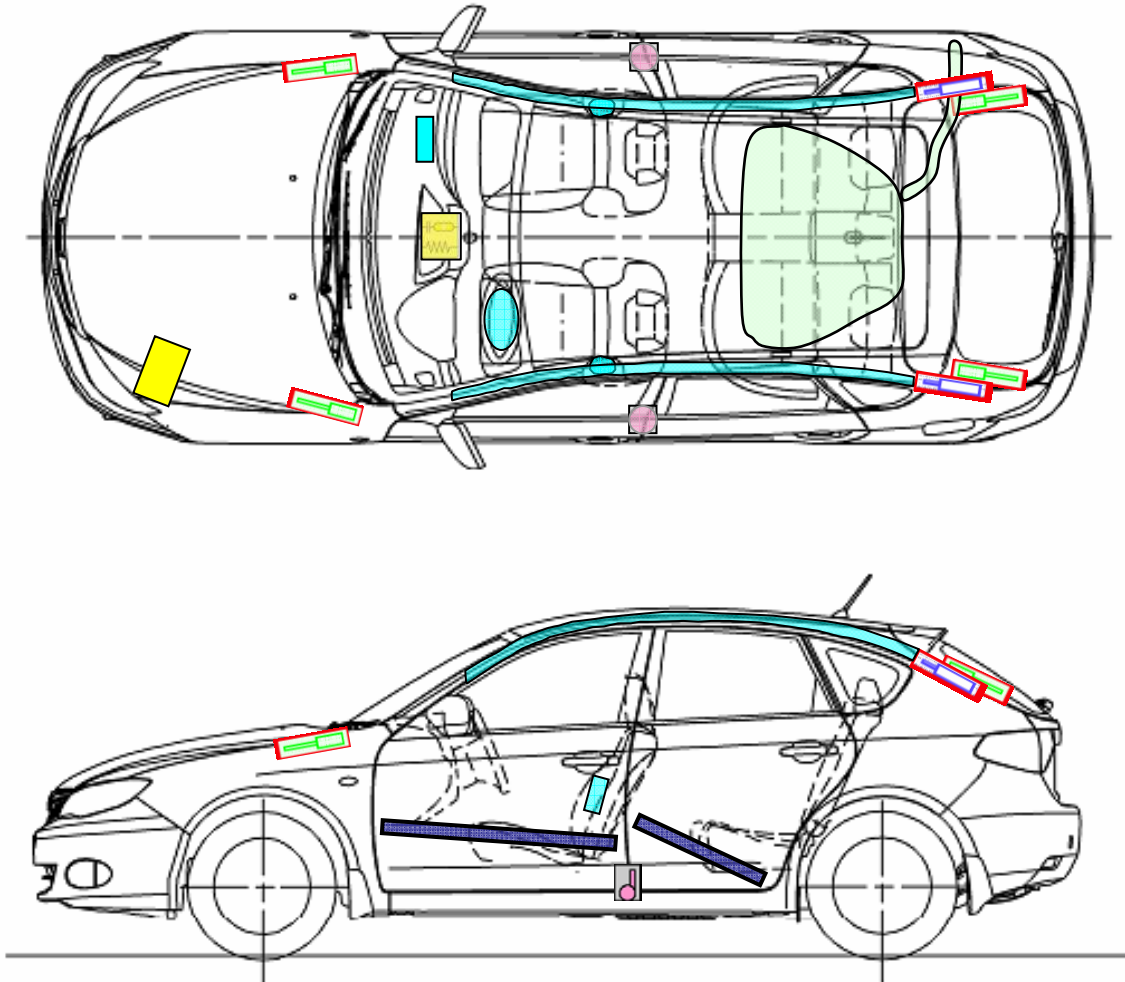

Airbag Modul		Karosserieverstärkung		Airbag Kontrollmodul	
Fensterairbag Gasgenerator				Batterie	
Gurtstraffer		Hauben & Heckklappendämpfer		Kraftstofftank	

Warnhinweise

Nach dem Abklemmen der Batterie 30 Sekunden warten.

SUBARU: Impreza
 Typ: G3
 Karosserievariante ab MJ 2008









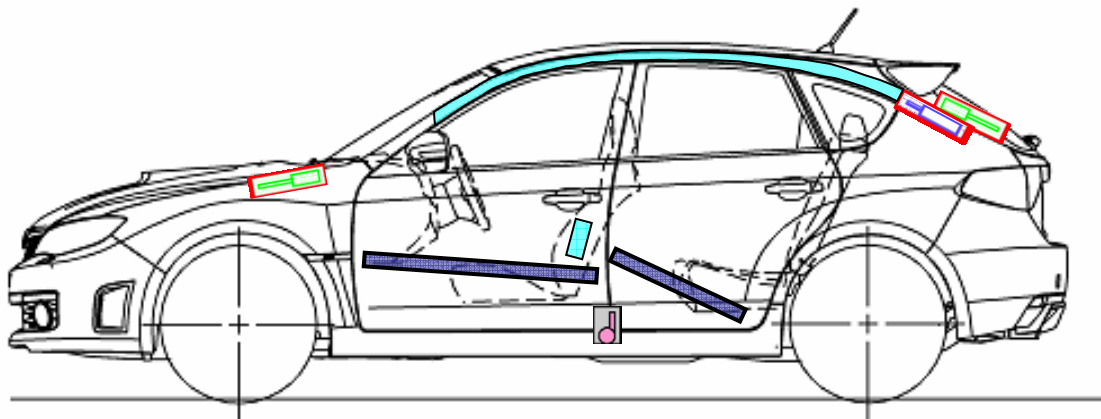
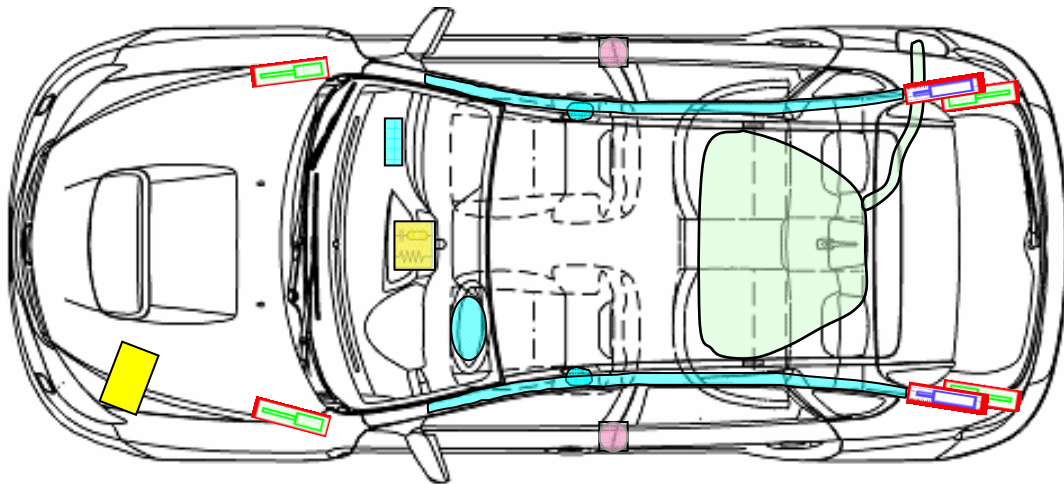

Airbag Module		Karosserieverstärkungen		Airbag Kontrollmodul	
Fensterairbag Gasgenerator				Batterie	
Gurtstraffer		Hauben & Heckklappendämpfer		Kraftstofftank	

Warnhinweise

Nach dem Abklemmen der Batterie 30 Sekunden warten.

SUBARU: Impreza STI
 Typ: G3
 Karosserievariante ab MJ 2008









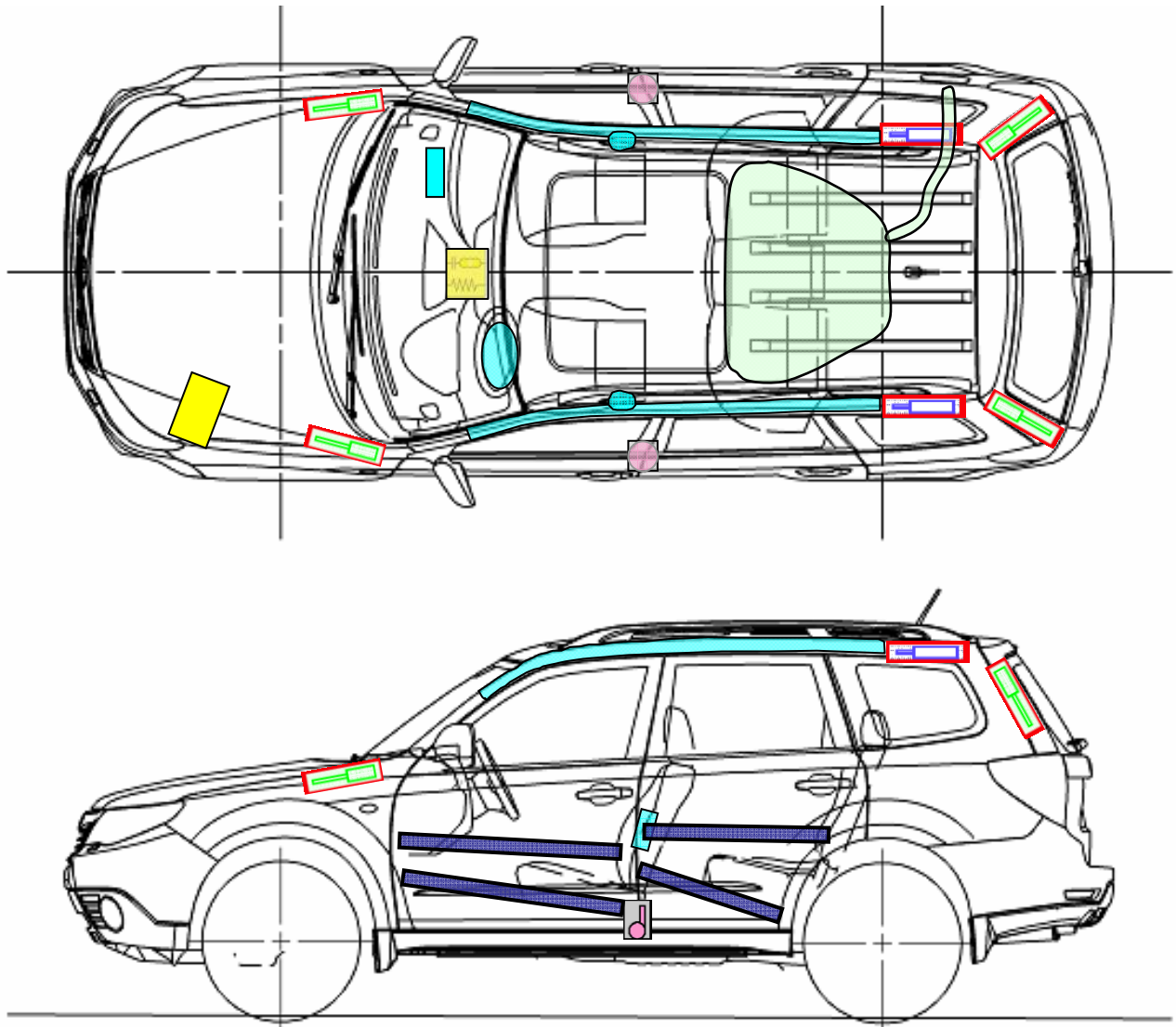

Airbag Modul		Karosserieverstärkungen		Airbag Kontrollmodul	
Fensterairbag Gasgenerator				Batterie	
Gurtstraffer		Hauben & Heckklappendämpfer		Kraftstofftank	

Warnhinweise

Nach dem Abklemmen der Batterie 30 Sekunden warten.

SUBARU: Forester
 Typ: SH / SHS
 Karosserievariante ab MJ 2009



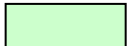





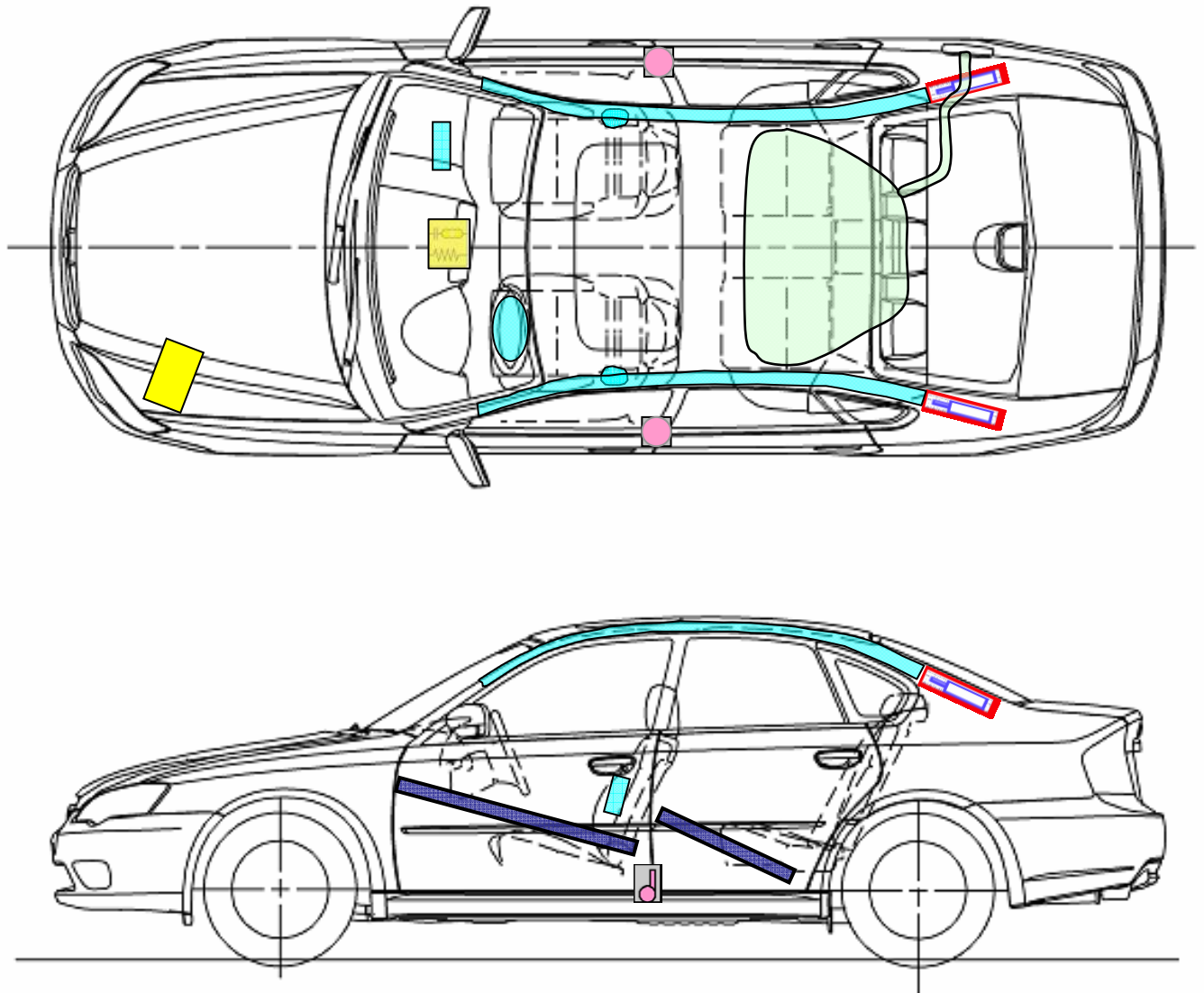

Airbag Modul		Karosserieverstärkungen		Airbag Kontrollmodul	
Fensterairbag Gasgenerator				Batterie	
Gurtstraffer		Hauben & Heckklappendämpfer		Kraftstofftank	

Warnhinweise

Nach dem Abklemmen der Batterie 30 Sekunden warten.

SUBARU: Legacy
 Typ: BL/BP
 BL/BPS
 Karosserievariante: MJ 2004 bis MJ 2009









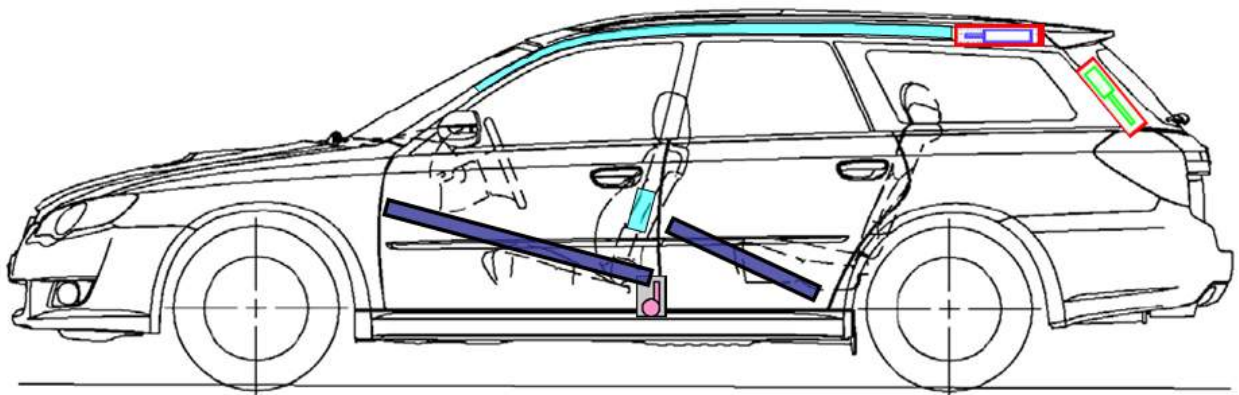
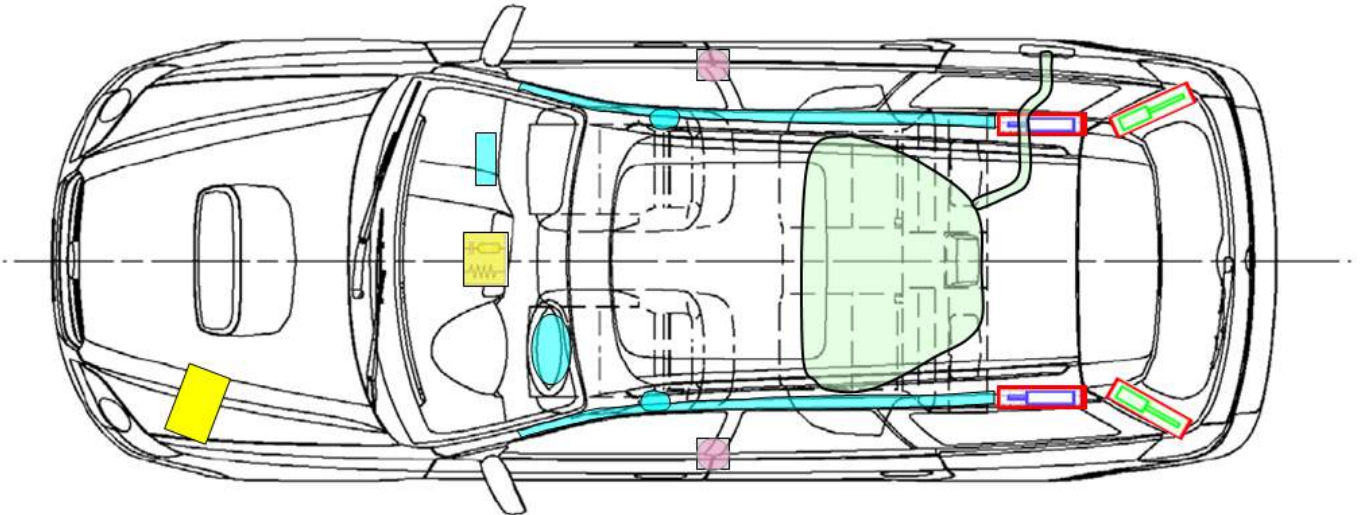

Airbag Modul		Karosserieverstärkung		Airbag Kontrollmodul	
Fensterairbag Gasgenerator				Batterie	
Gurtstraffer		Hauben & Heckklappendämpfer		Kraftstofftank	

Warnhinweise

Nach dem Abklemmen der Batterie 30 Sekunden warten.

SUBARU: Legacy
 Typ: BL/BP
 BL/BPS
 Karosserieversion MJ 2004 bis MJ 2009









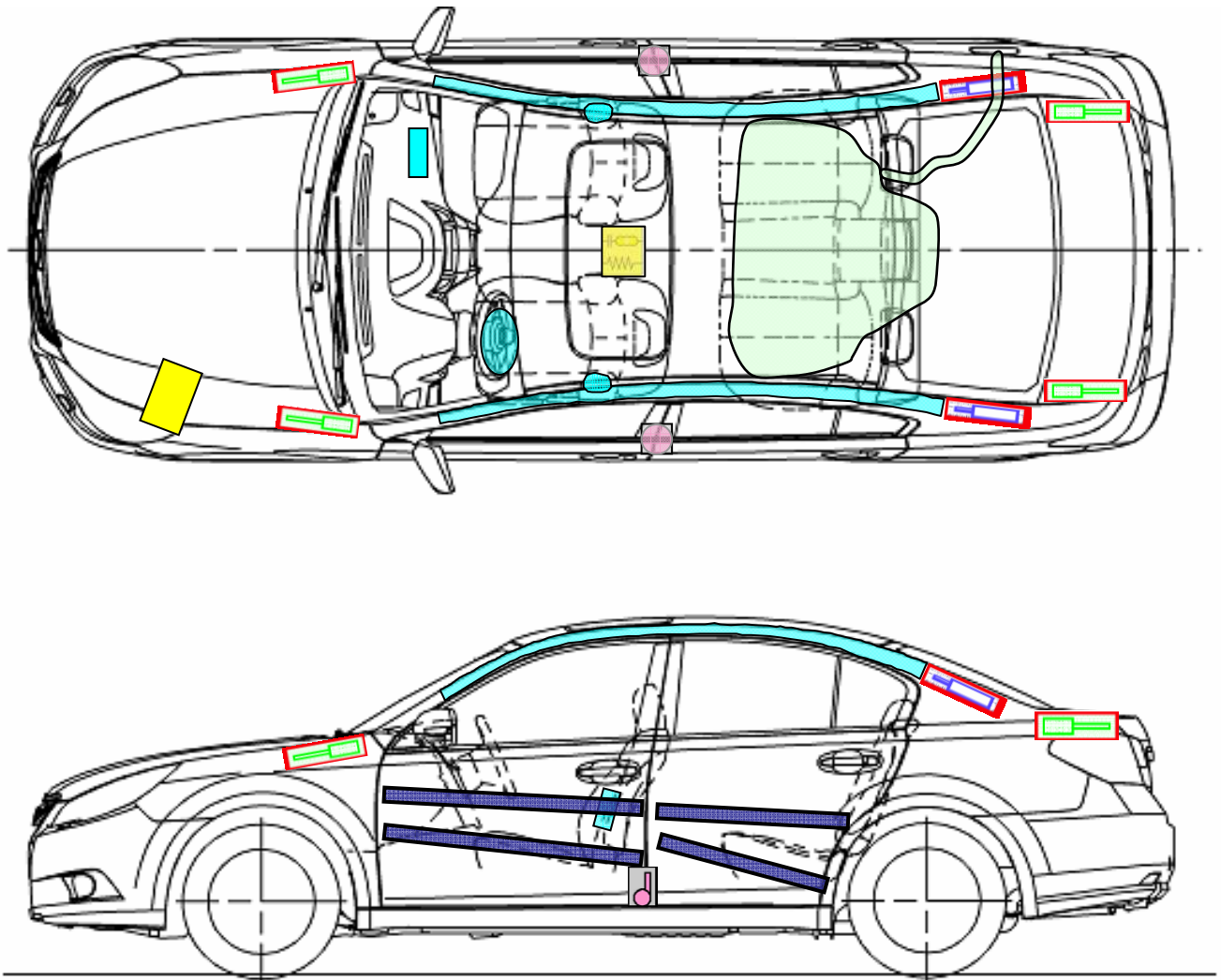

Airbag Modul		Karosserieverstärkungen		Airbag Kontrollmodul	
Fensterairbag Gasgenerator				Batterie	
Gurtstraffer		Hauben & Heckklappendämpfer		Kraftstofftank	

Warnhinweise

Nach dem Abklemmen der Batterie 30 Sekunden warten.

SUBARU: Legacy
 Typ: BM/BR
 BM/BRS
 Karosserievariante ab MJ 2010









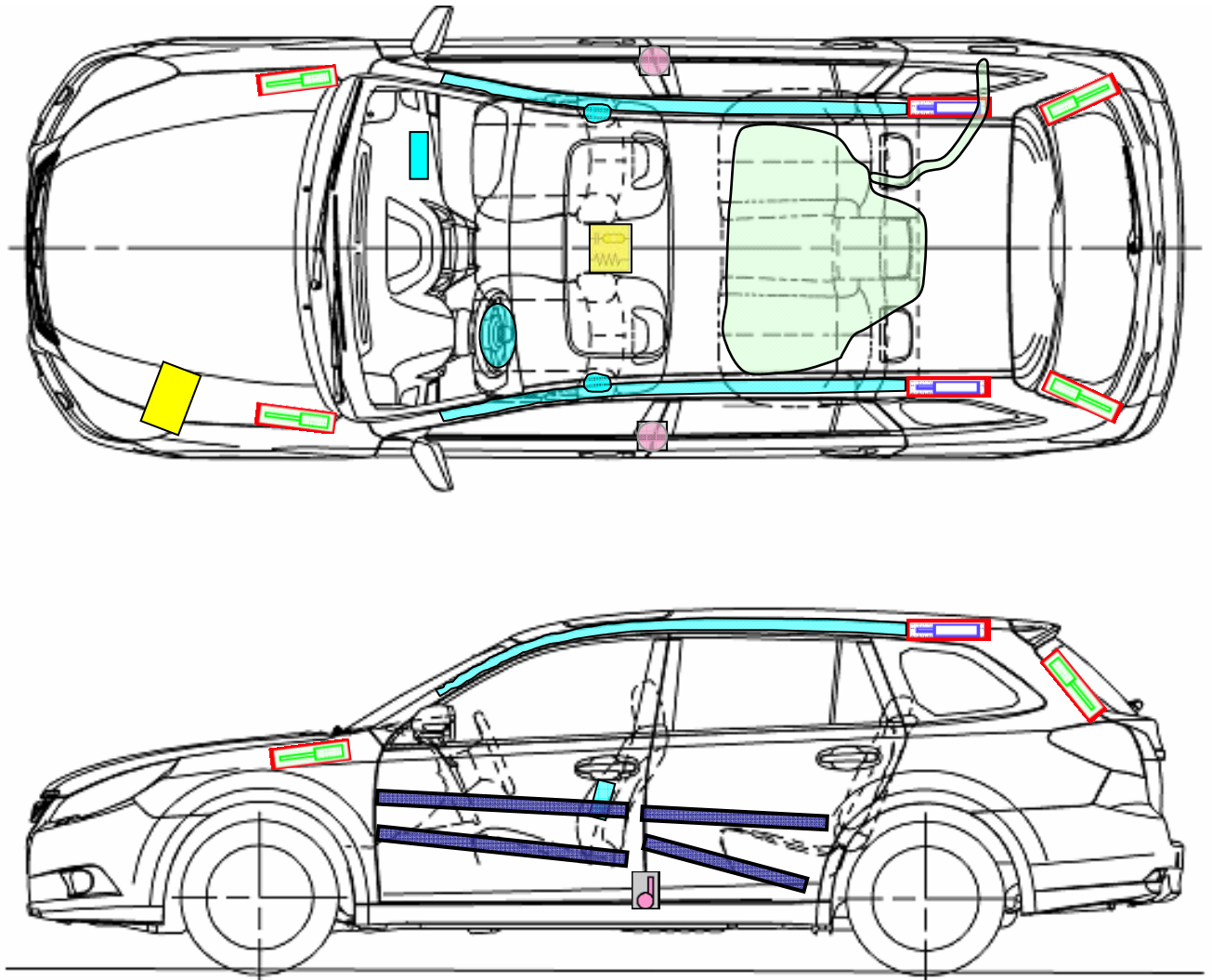

Airbag Modul		Karosserieverstärkungen		Airbag Kontrollmodul	
Fensterairbag Gasgenerator				Batterie	
Gurtstraffer		Hauben & Heckklappendämpfer		Kraftstofftank	

Warnhinweise

Nach dem Abklemmen der Batterie 30 Sekunden warten.

SUBARU: Legacy
 Typ: BM/BR
 BM/BRS
 Karosserievariante ab MJ 2010









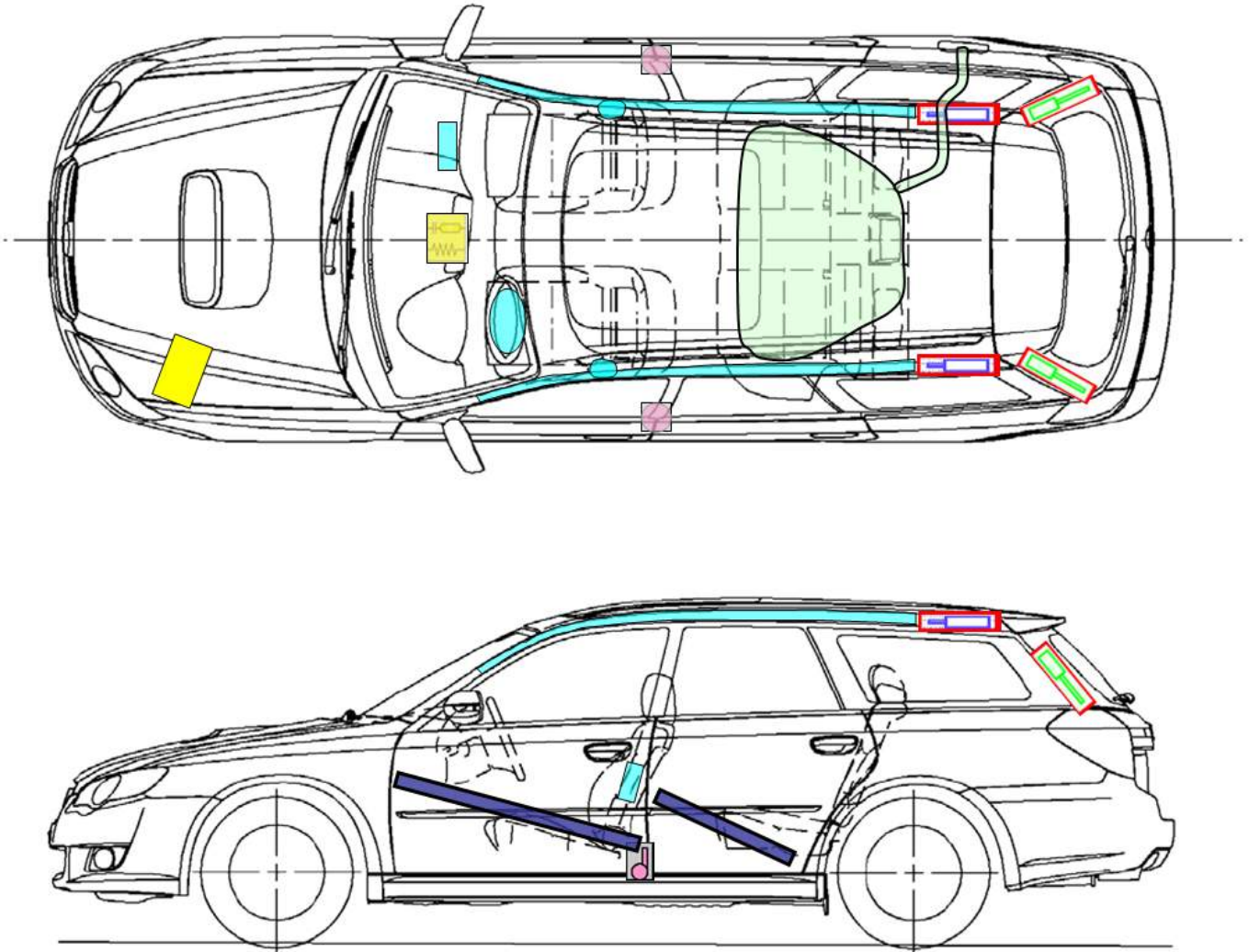

Airbag Modul		Karosserieverstärkung		Airbag Kontrollmodul	
Fensterairbag Gasgenerator				Batterie	
Gurtstraffer		Hauben & Heckklappendämpfer		Kraftstofftank	

Warnhinweise

Nach dem Abklemmen der Batterie 30 Sekunden warten.

SUBARU: Outback
 Typ: BL/BP
 BL/BPS
 Karosserieversion MJ 2004 bis MJ 2009









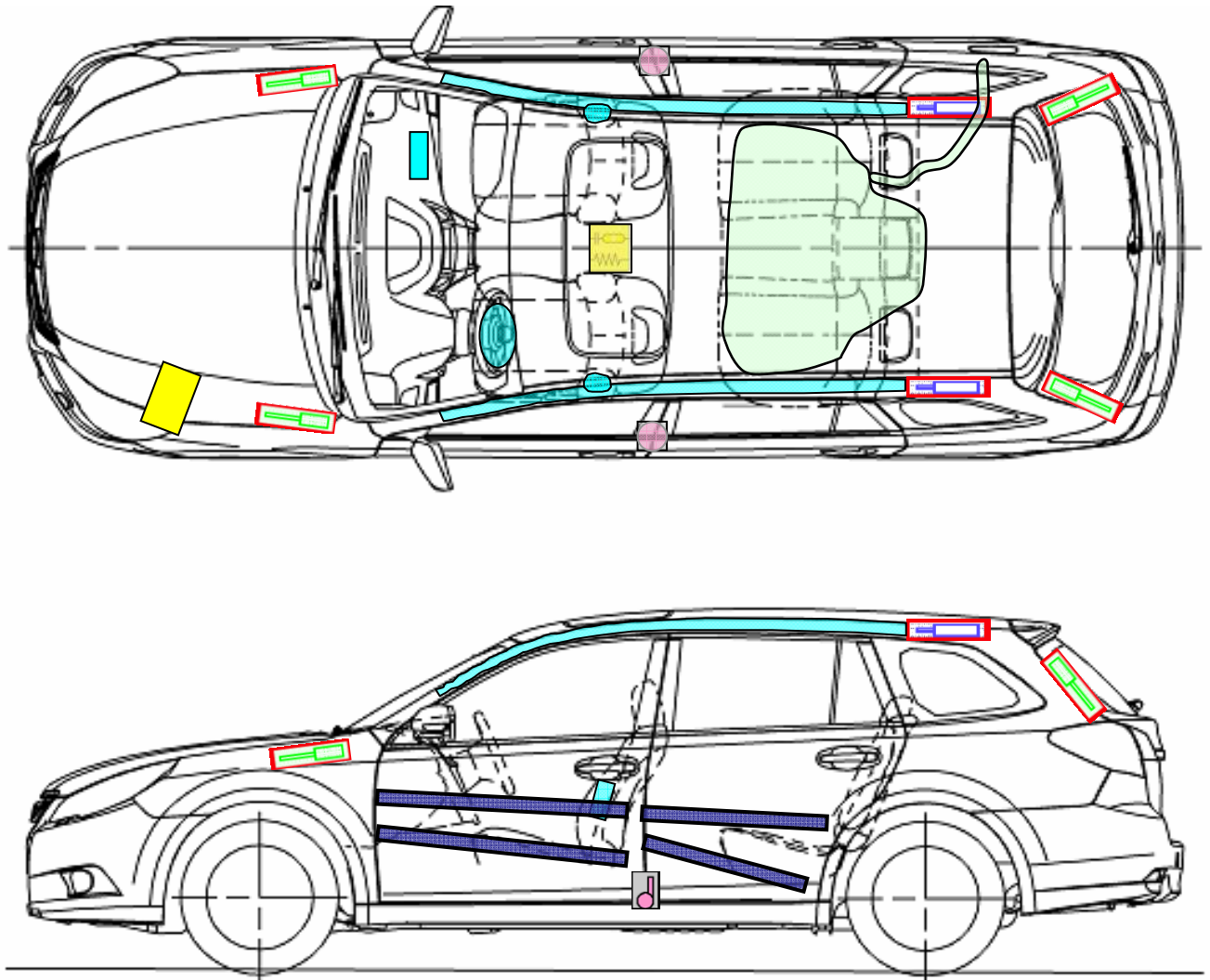

Airbag Modul		Karosserieverstärkungen		Airbag Kontrollmodul	
Fensterairbag Gasgenerator				Batterie	
Gurtstraffer		Hauben & Heckklappendämpfer		Kraftstofftank	

Warnhinweise

Nach dem Abklemmen der Batterie 30 Sekunden warten.

SUBARU: Outback
 Typ: BM/BR
 BM/BRS
 Karosserievariante ab MJ 2010



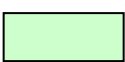





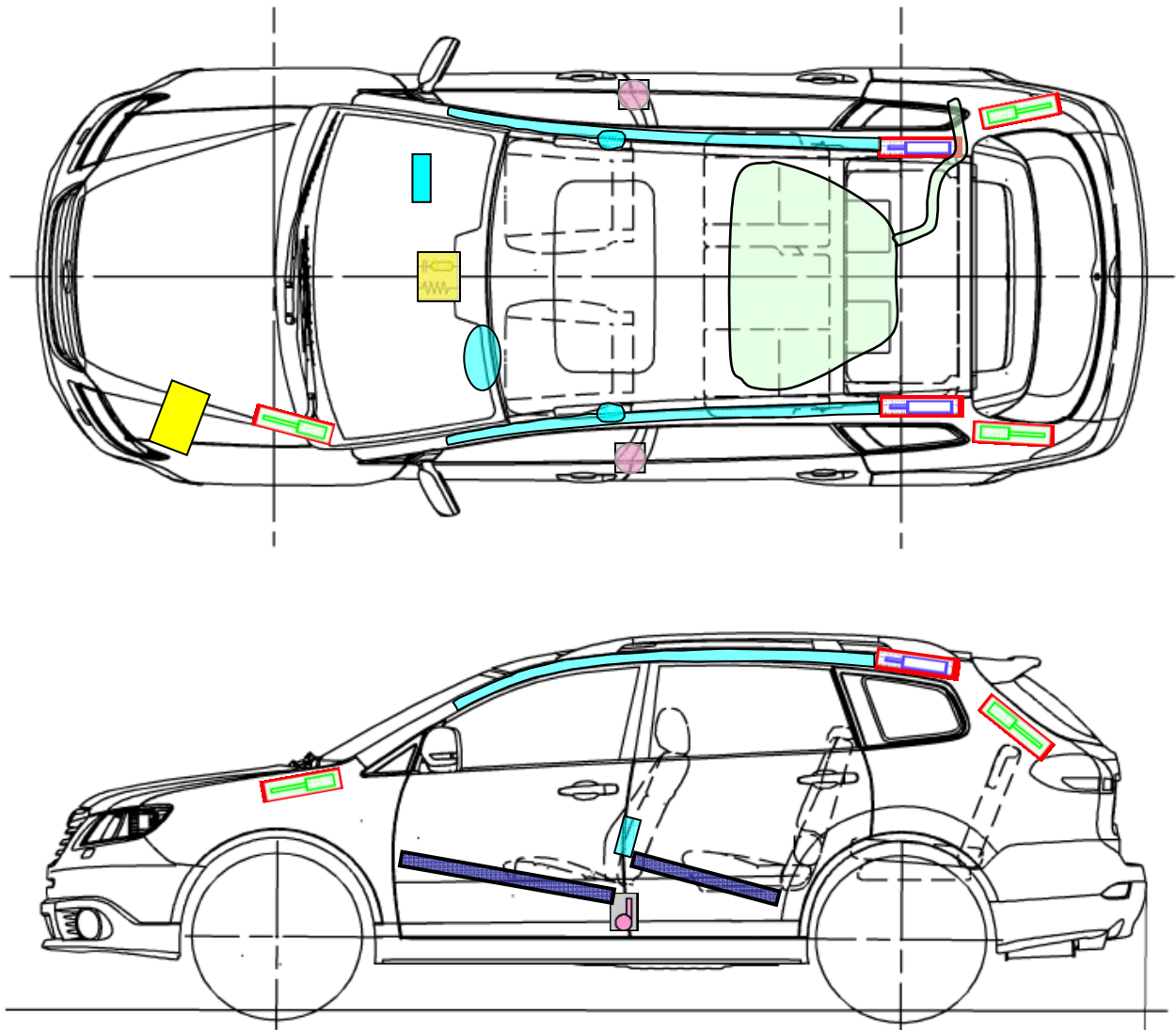

Airbag Modul		Karosserieverstärkung		Airbag Kontrollmodul	
Fensterairbag Gasgenerator				Batterie	
Gurtstraffer		Hauben & Heckklappendämpfer		Kraftstofftank	

Warnhinweise

Nach dem Abklemmen der Batterie 30 Sekunden warten.

SUBARU: Tribeca
 Typ: WX
 Karosserievariante ab MJ 2008









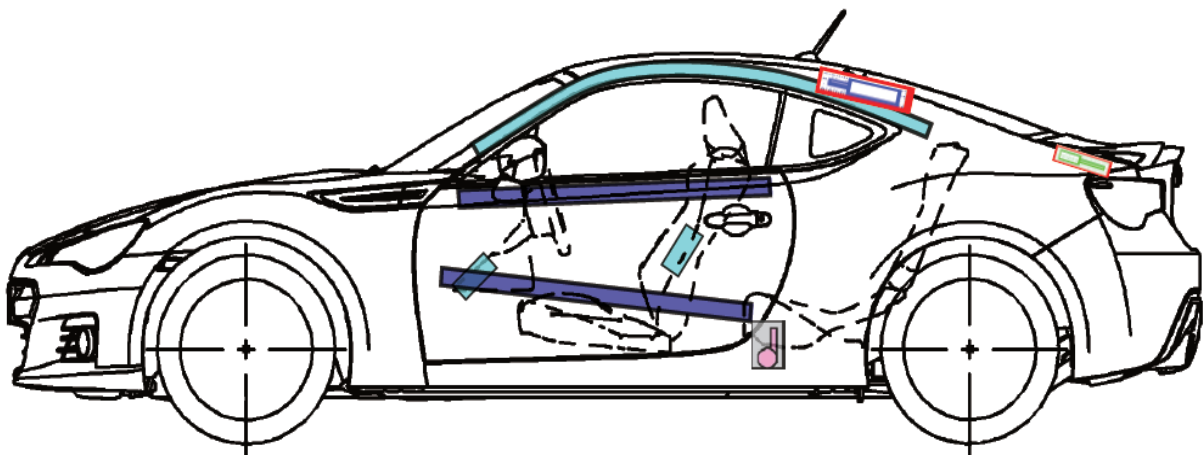
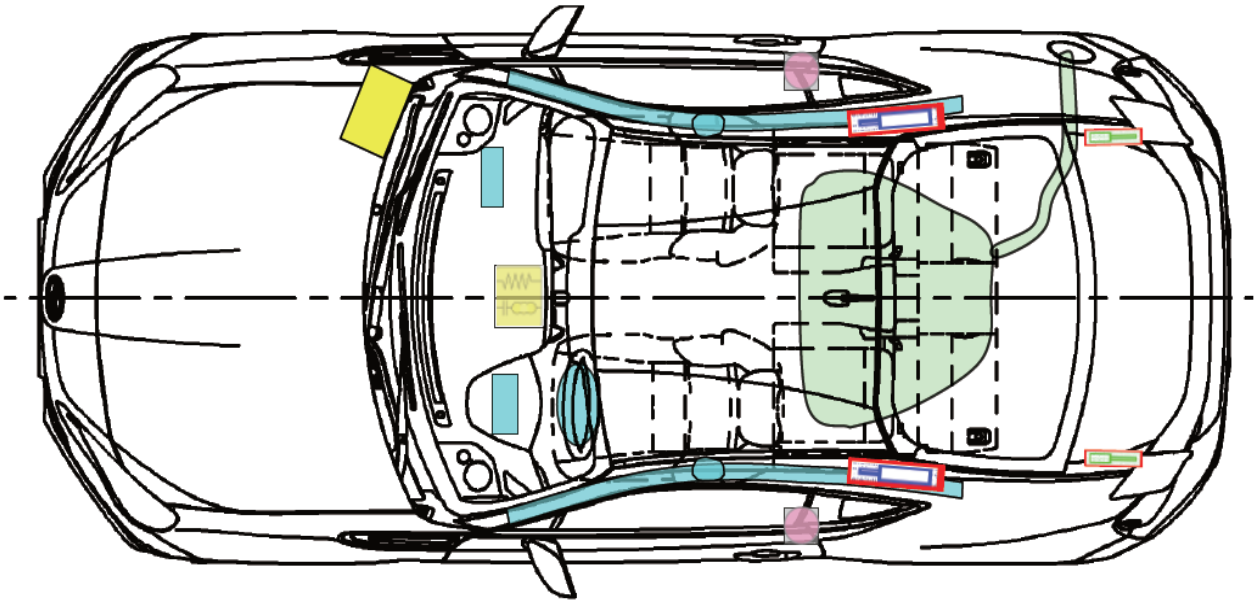

Airbag Modul		Karosserieverstärkungen		Airbag Kontrollmodul	
Fensterairbag Gasgenerator				Batterie	
Gurtstraffer		Hauben & Heckklappendämpfer		Kraftstofftank	

Warnhinweise

Nach dem Abklemmen der Batterie 30 Sekunden warten.

SUBARU: BRZ
 Typ: ZC
 Karosserieversion ab MJ 2013



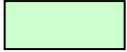





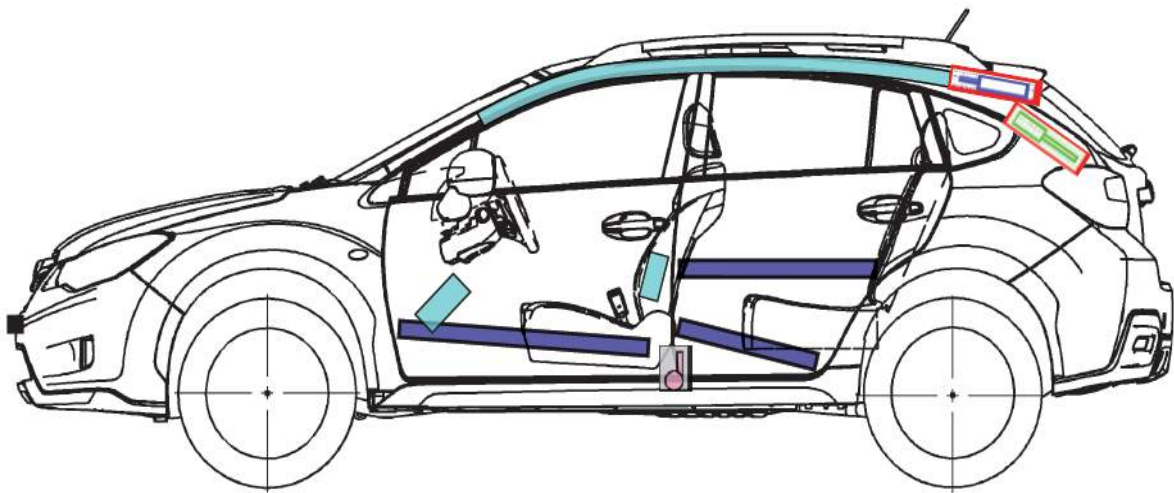
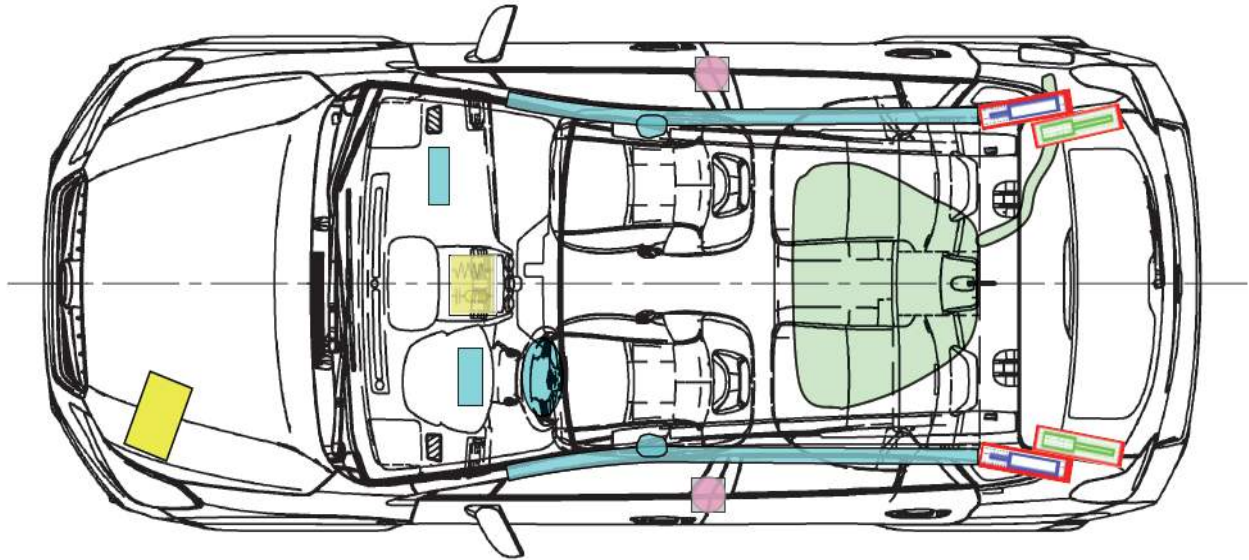

Airbag Modul		Karosserieverstärkungen		Airbag Kontrollmodul	
Fensterairbag Gasgenerator				Batterie	
Gurtstraffer		Hauben & Heckklappendämpfer		Kraftstofftank	

Warnhinweise

Nach dem Abklemmen der Batterie 30 Sekunden warten.

SUBARU: XV
 Typ: G4
 Karosserieversion ab MJ 2012









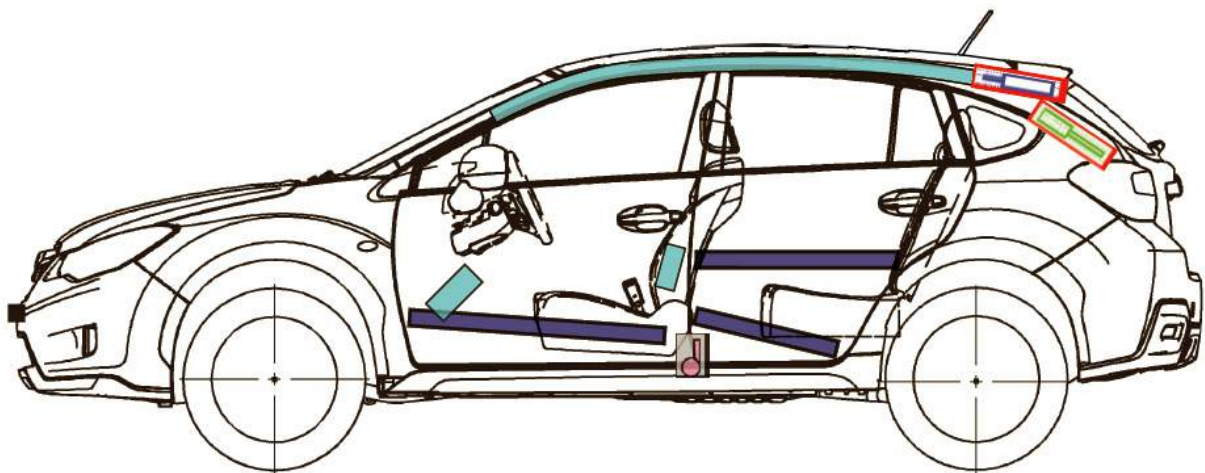
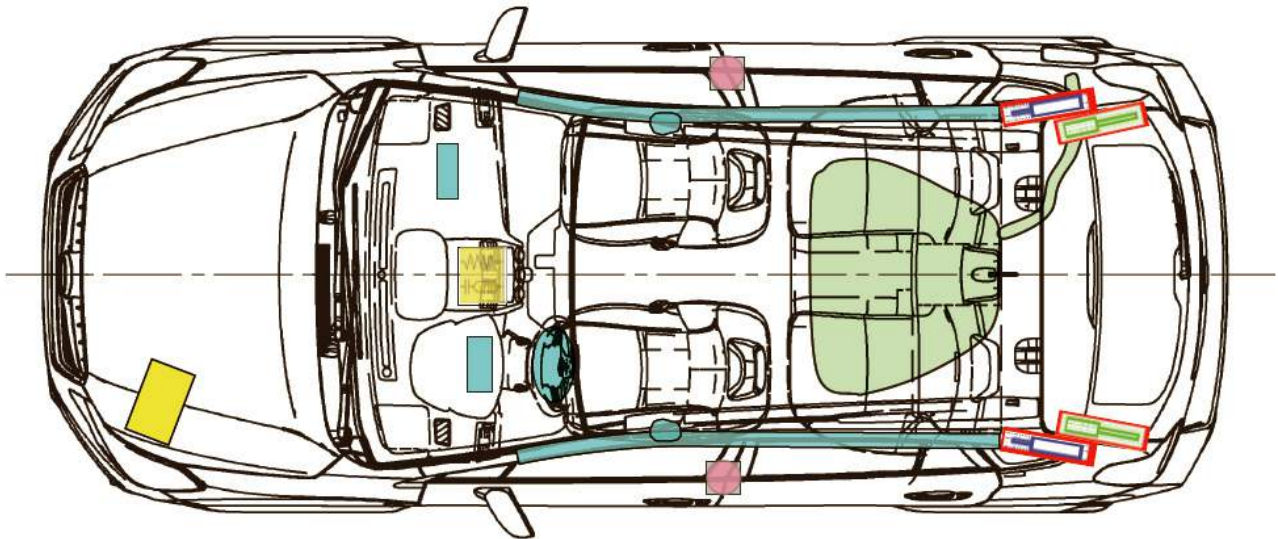

Airbag Modul		Karosserieverstärkungen		Airbag Kontrollmodul	
Fensterairbag Gasgenerator				Batterie	
Gurtstraffer		Hauben & Heckklappendämpfer		Kraftstofftank	

Warnhinweise

Nach dem Abklemmen der Batterie 30 Sekunden warten.

SUBARU: Impreza
 Typ: G4
 Karosserieversion ab MJ 2012









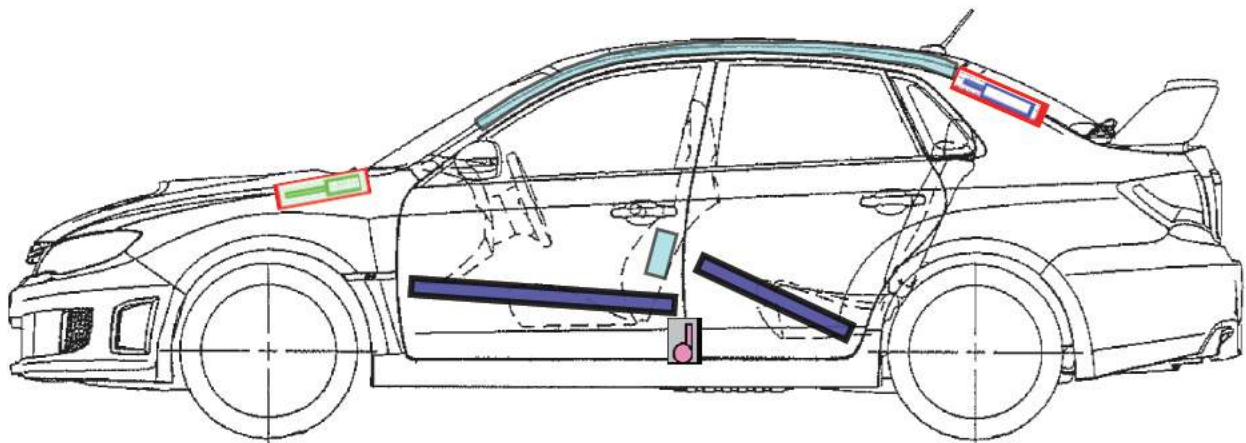
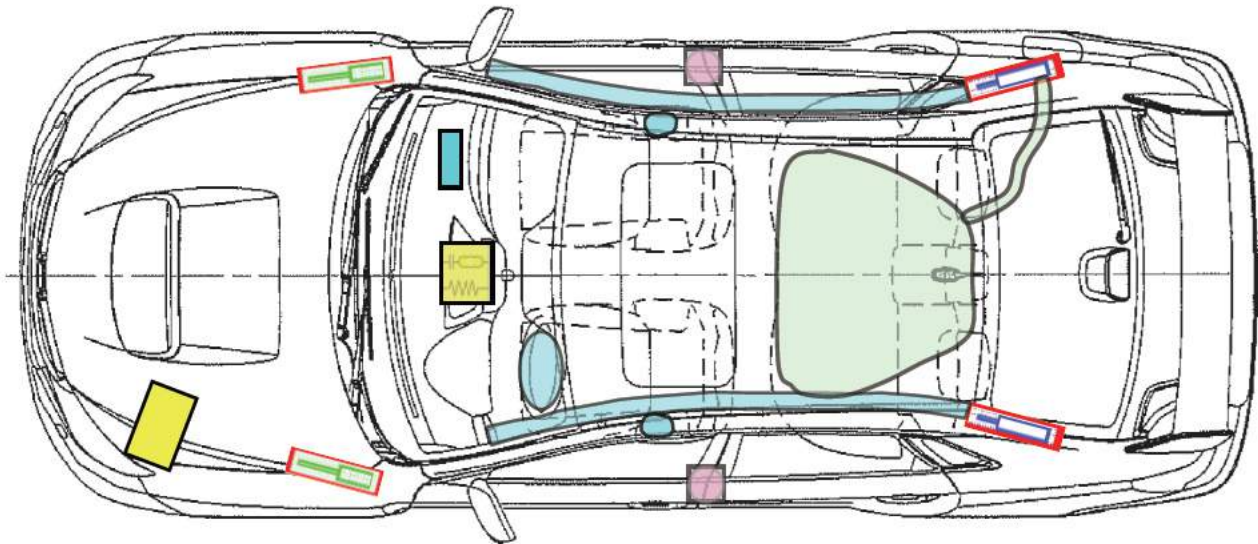

Airbag Modul		Karosserieverstärkungen		Airbag Kontrollmodul	
Fensterairbag Gasgenerator				Batterie	
Gurtstraffer		Hauben & Heckklappendämpfer		Kraftstofftank	

Warnhinweise

Nach dem Abklemmen der Batterie 30 Sekunden warten.

SUBARU: Impreza STI
 Typ: GVF
 Karosserievariante ab MJ 2010



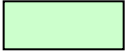





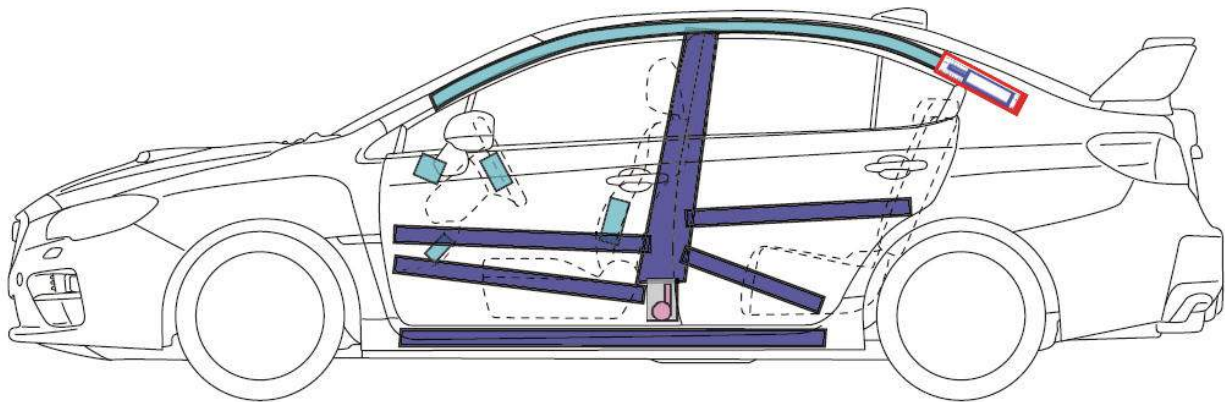
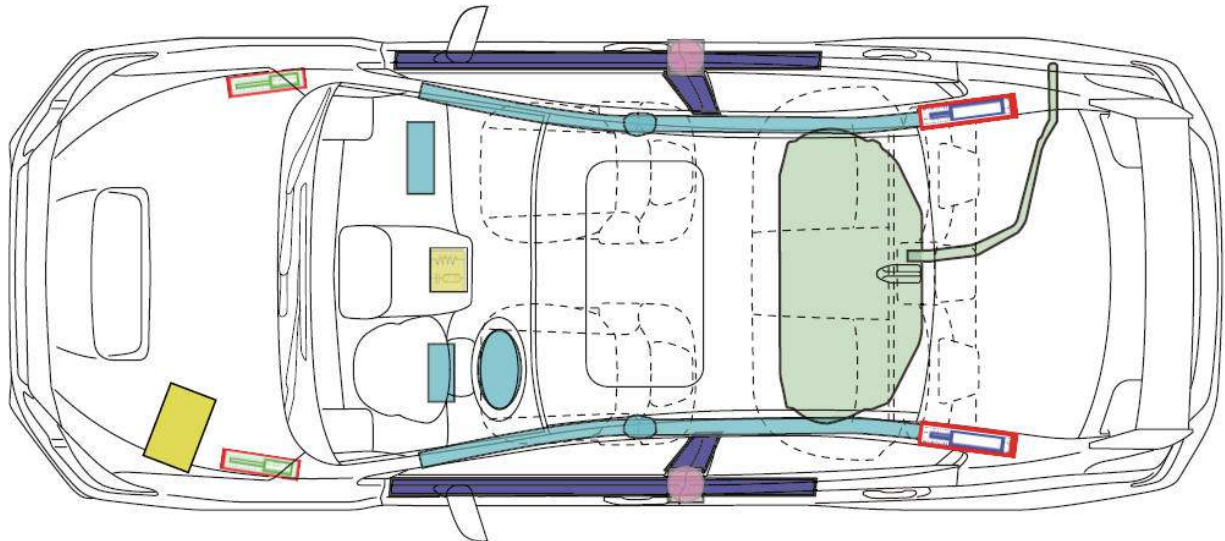

Airbag Modul		Karosserieverstärkungen		Airbag Kontrollmodul	
Fensterairbag Gasgenerator				Batterie	
Gurtstraffer		Hauben & Heckklappendämpfer		Kraftstofftank	

Warnhinweise

Nach dem Abklemmen der Batterie 30 Sekunden warten.

SUBARU: WRX STI
 Typ: V1
 Karosserievariante ab MJ 2015



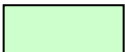





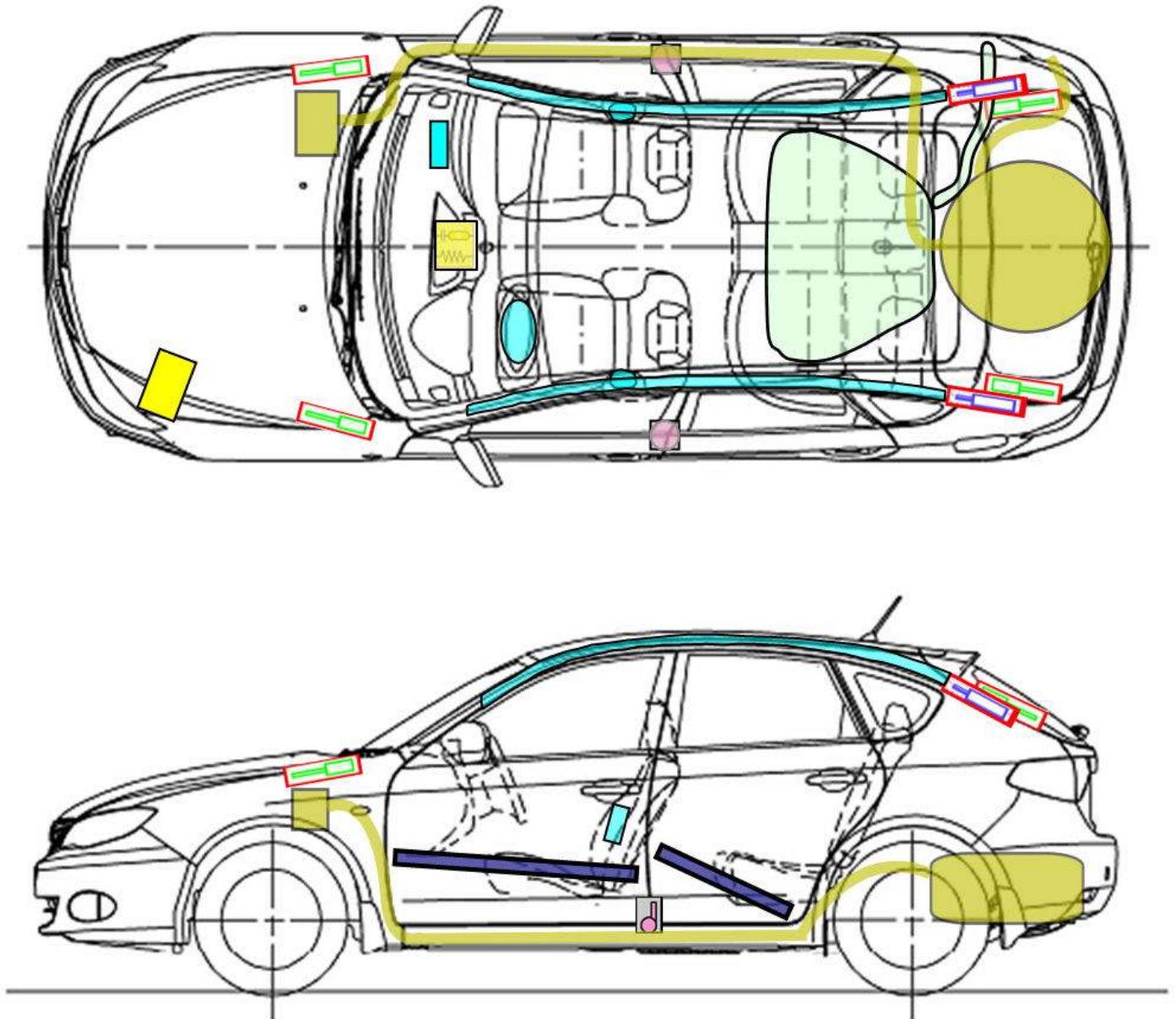

Airbag Modul		Karosserieverstärkungen		Airbag Kontrollmodul	
Fensterairbag Gasgenerator				Batterie	
Gurtstraffer		Hauben & Heckklappendämpfer		Kraftstofftank	

Warnhinweise

Nach dem Abklemmen der Batterie 30 Sekunden warten.

SUBARU: Impreza
 Typ: G3
 Karosserievariante ab MJ 2008



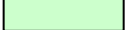





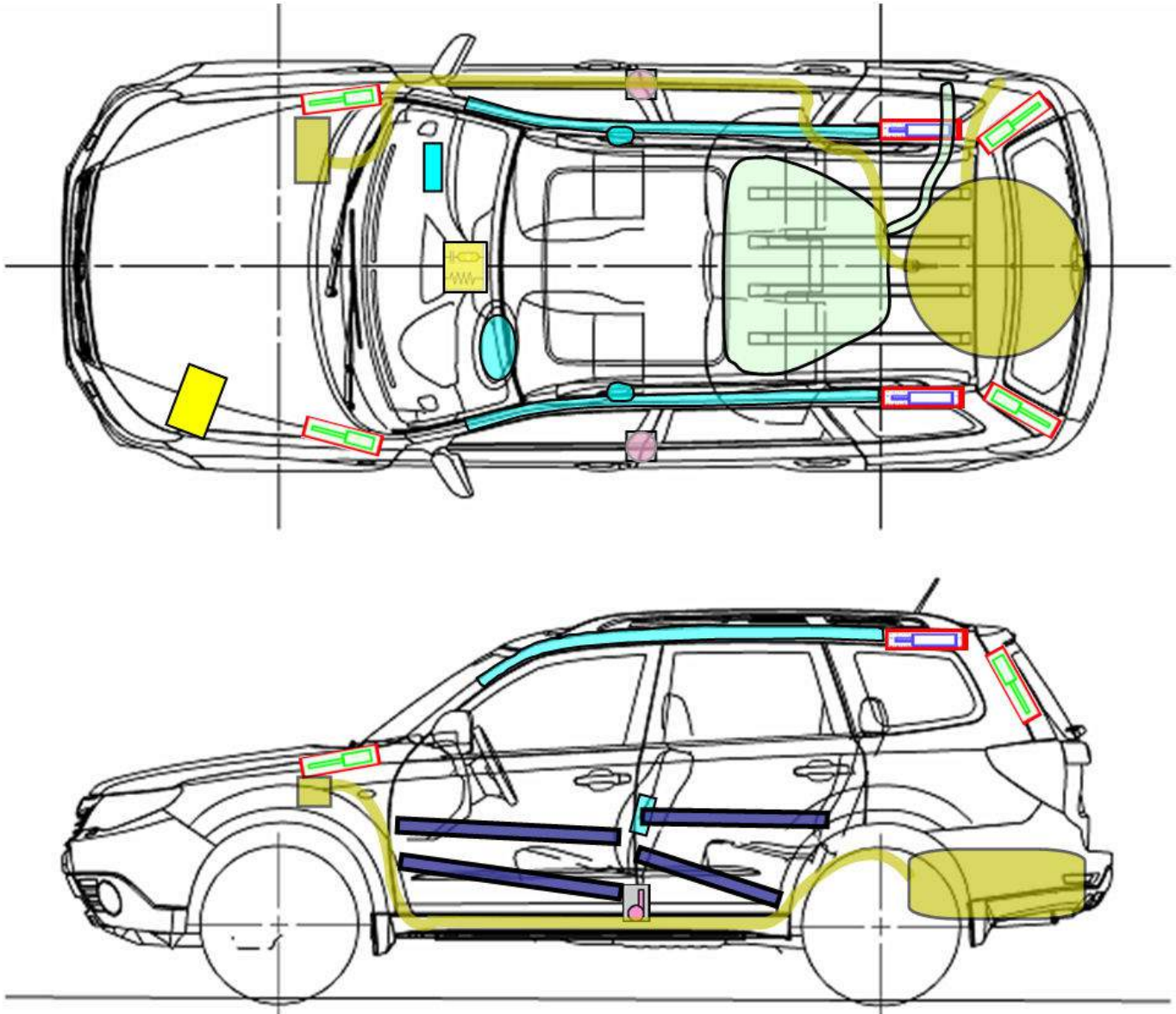

Airbag Module		Karosserieverstärkungen		Airbag Kontrollmodul	
Fensterairbag Gasgenerator		Autogasanlage		Batterie	
Gurtstraffer		Hauben & Heckklappendämpfer		Kraftstofftank	

Warnhinweise

Nach dem Abklemmen der Batterie 30 Sekunden warten.

SUBARU: Forester
 Typ: SH / SHS
 Karosserievariante ab MJ 2009



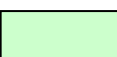







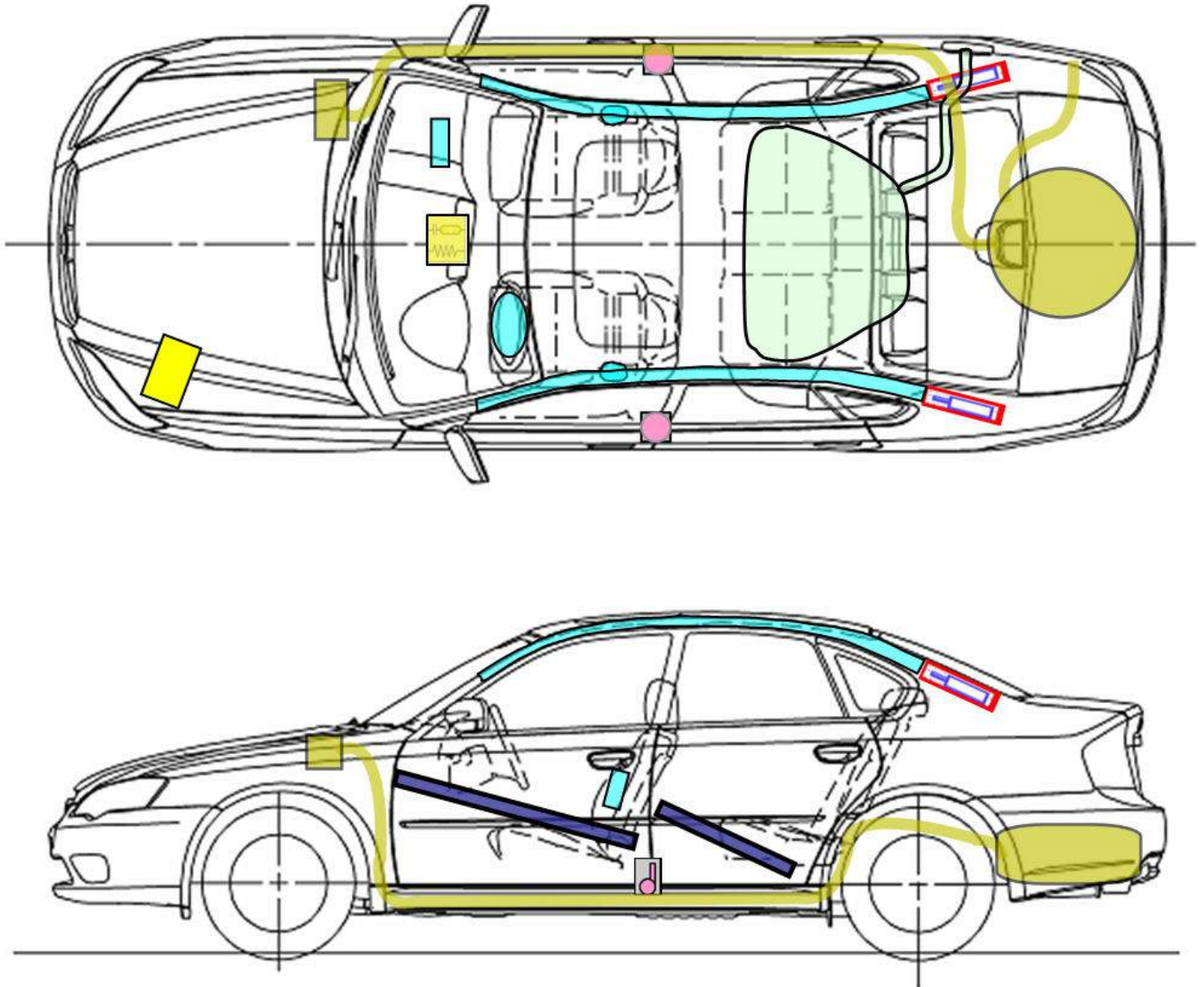

Airbag Modul		Karosserieverstärkungen		Airbag Kontrollmodul	
Fensterairbag Gasgenerator		Autogasanlage		Batterie	
Gurtstraffer		Hauben & Heckklappendämpfer		Kraftstofftank	

Warnhinweise

Nach dem Abklemmen der Batterie 30 Sekunden warten.

SUBARU: Legacy
 Typ: BL/BP
 BL/BPS
 Karosserievariante: MJ 2004 bis MJ 2009

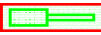









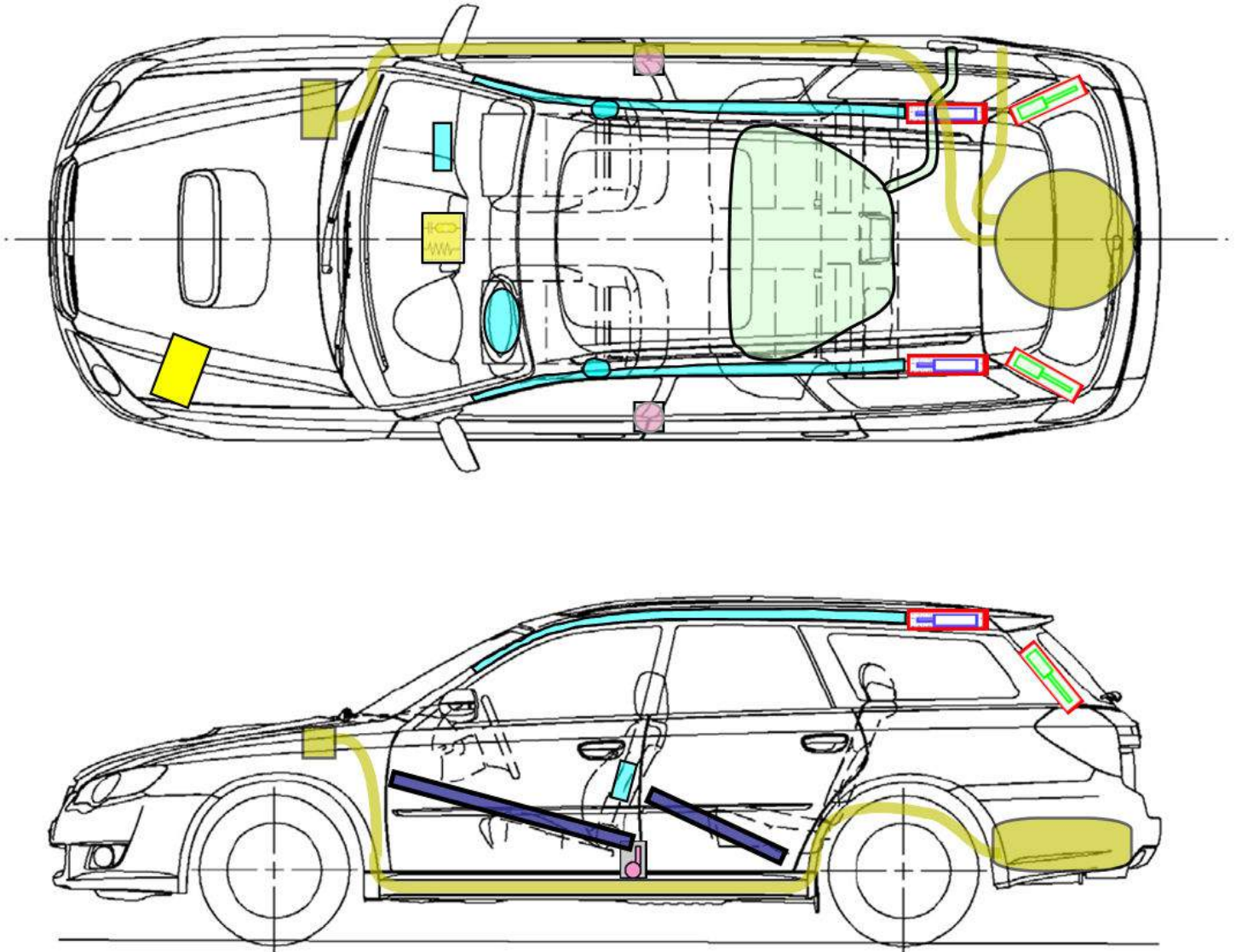

Airbag Modul		Karosserieverstärkung		Airbag Kontrollmodul	
Fensterairbag Gasgenerator		Autogasanlage		Batterie	
Gurtstraffer		Hauben & Heckklappendämpfer		Kraftstofftank	

Warnhinweise

Nach dem Abklemmen der Batterie 30 Sekunden warten.

SUBARU: Legacy
 Typ: BL/BP
 BL/BPS
 Karosserieversion MJ 2004 bis MJ 2009











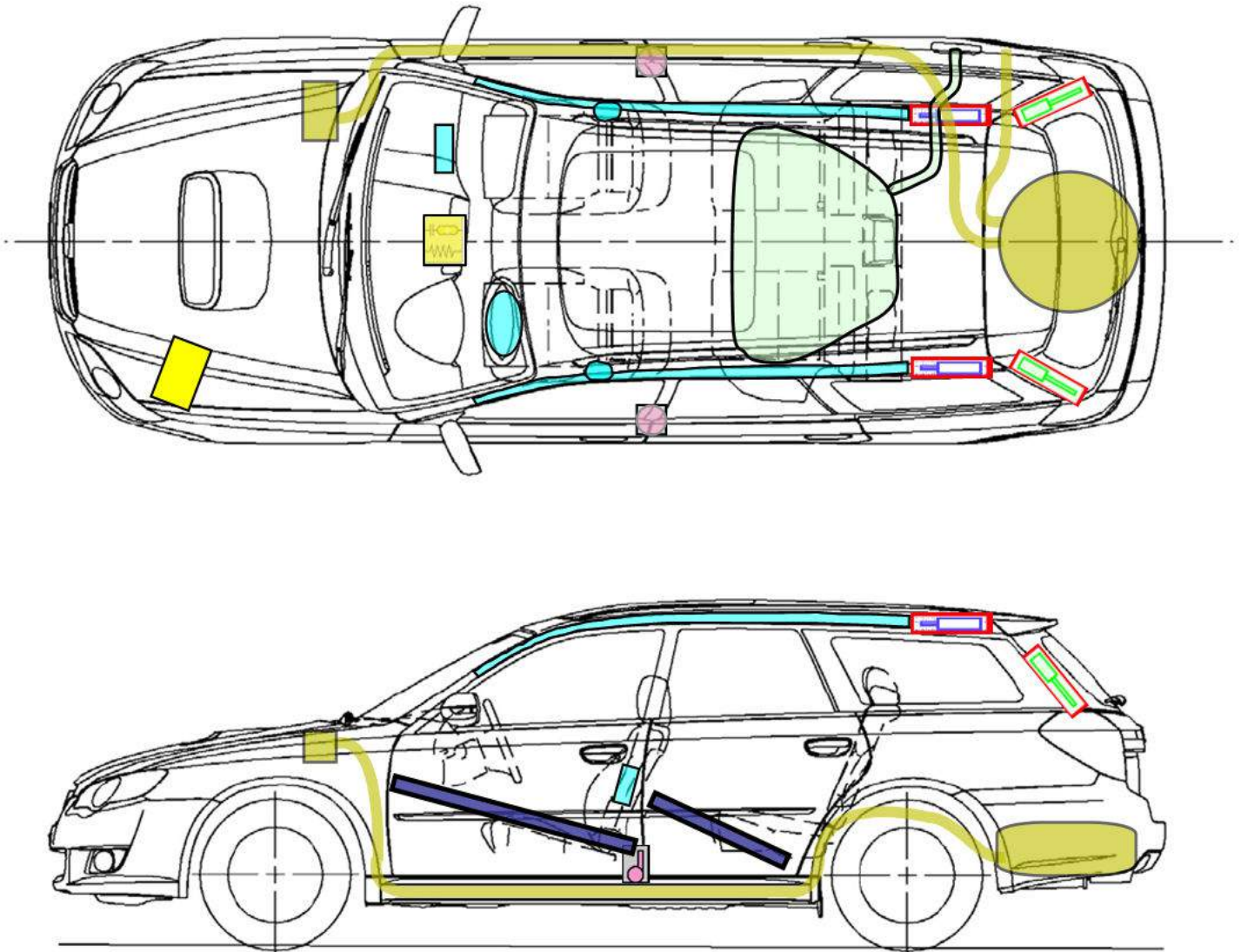

Airbag Modul		Karosserieverstärkungen		Airbag Kontrollmodul	
Fensterairbag Gasgenerator		Autogasanlage		Batterie	
Gurtstraffer		Hauben & Heckklappendämpfer		Kraftstofftank	

Warnhinweise

Nach dem Abklemmen der Batterie 30 Sekunden warten.

SUBARU: Outback
 Typ: BL/BP
 BL/BPS
 Karosserieversion MJ 2004 bis MJ 2009











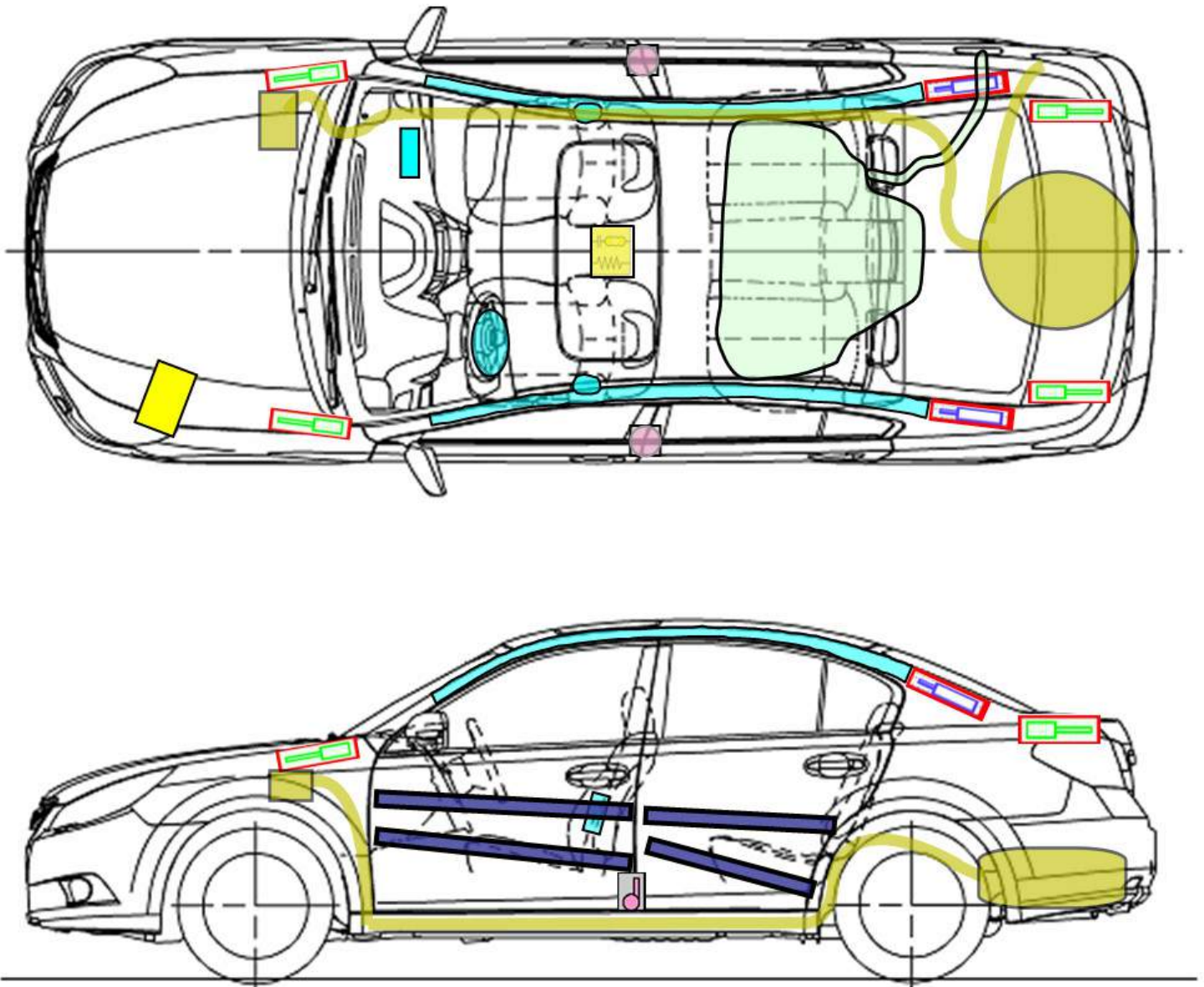

Airbag Modul		Karosserieverstärkungen		Airbag Kontrollmodul	
Fensterairbag Gasgenerator		Autogasanlage		Batterie	
Gurtstraffer		Hauben & Heckklappendämpfer		Kraftstofftank	

Warnhinweise

Nach dem Abklemmen der Batterie 30 Sekunden warten.

SUBARU: Legacy Limousine
 Typ: BM/BR
 BM/BRS
 Karosserievariante ab MJ 2010
 Mit ecomatic® Autogasanlage











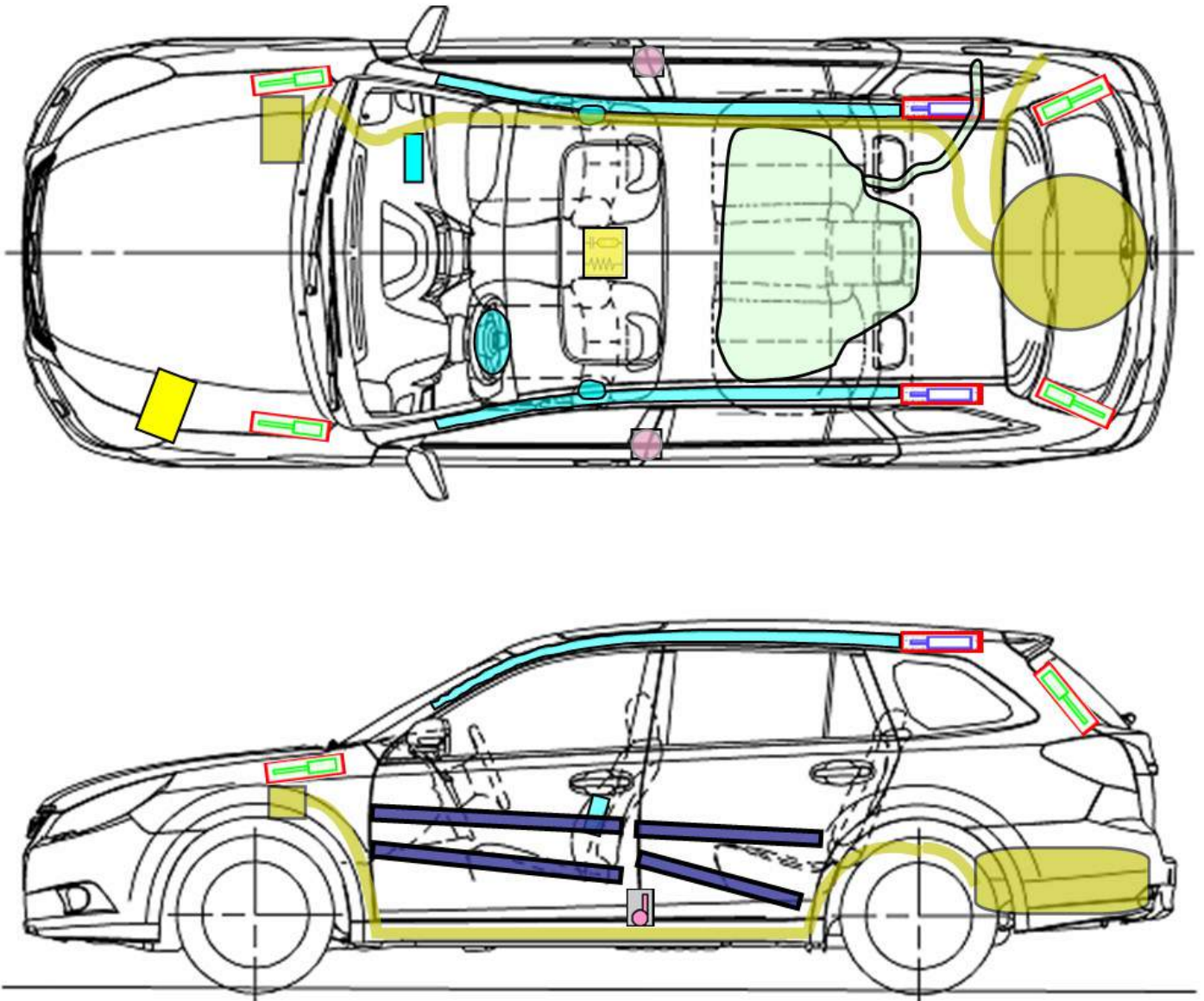

Airbag Modul		Karosserieverstärkungen		Airbag Kontrollmodul	
Fensterairbag Gasgenerator		Autogasanlage		Batterie	
Gurtstraffer		Hauben & Heckklappendämpfer		Kraftstofftank	

Warnhinweise

Nach dem Abklemmen der Batterie 30 Sekunden warten.

SUBARU: Legacy Kombi
 Typ: BM/BR
 BM/BRS
 Karosserievariante ab MJ 2010
 Mit ecomatic® Autogasanlage











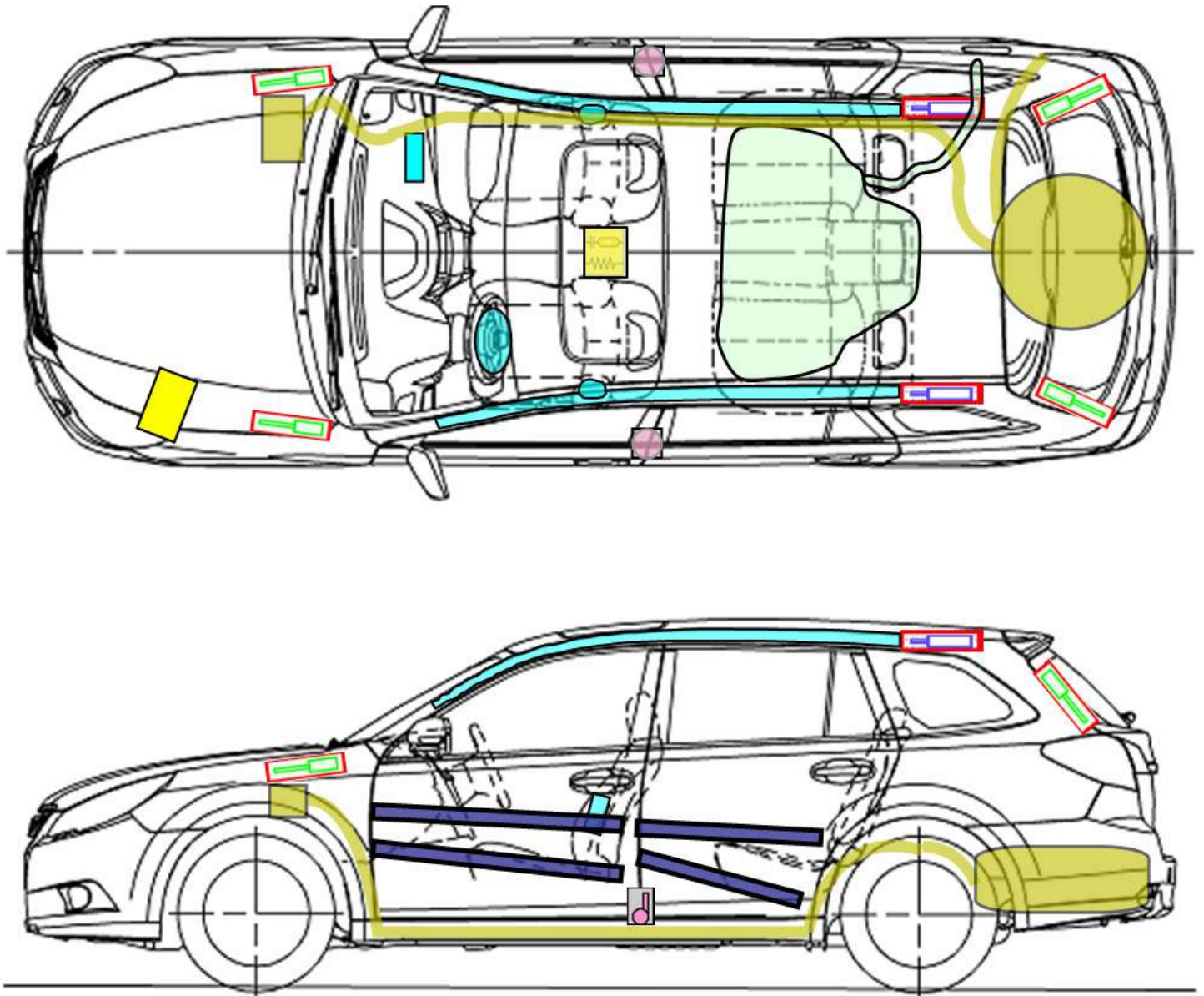

Airbag Modul		Karosserieverstärkung		Airbag Kontrollmodul	
Fensterairbag Gasgenerator		Autogasanlage		Batterie	
Gurtstraffer		Hauben & Heckklappendämpfer		Kraftstofftank	

Warnhinweise

Nach dem Abklemmen der Batterie 30 Sekunden warten.

SUBARU: Outback
 Typ: BM/BR
 BM/BRS
 Karosserievariante ab MJ 2010
 Mit ecomatic® Autogasanlage









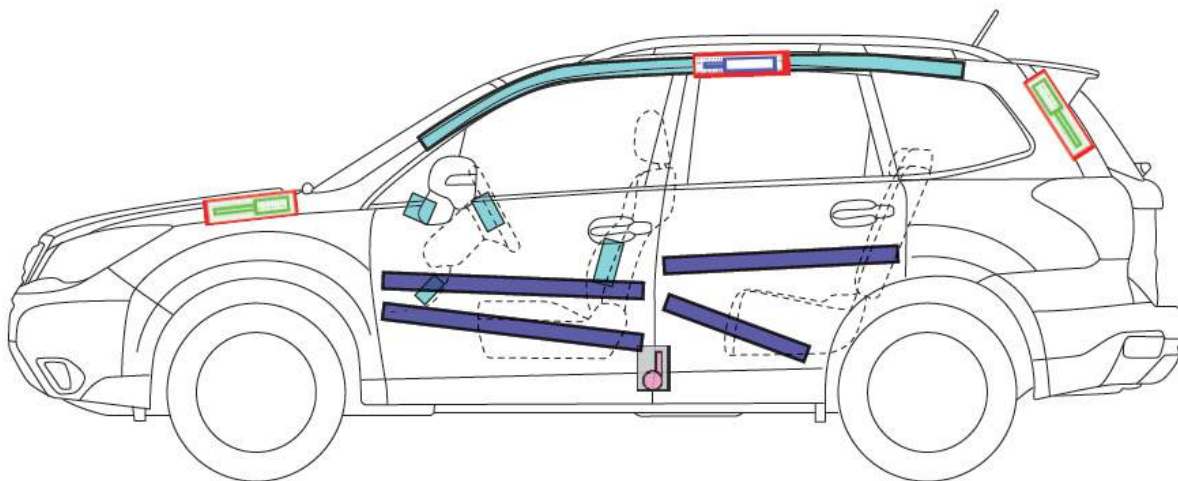
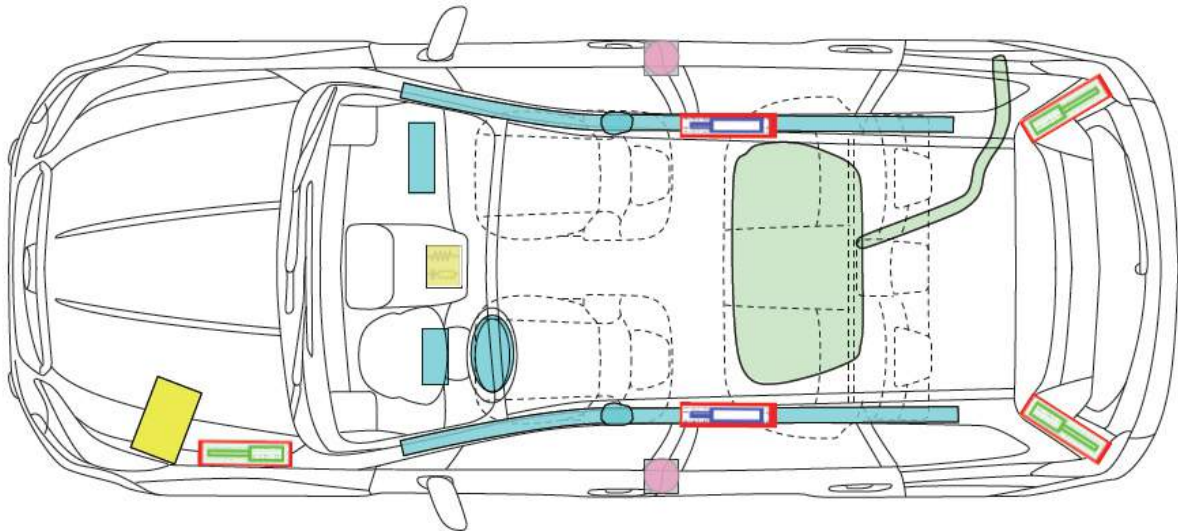

Airbag Modul		Karosserieverstärkung		Airbag Kontrollmodul	
Fensterairbag Gasgenerator		Autogasanlage		Batterie	
Gurtstraffer		Hauben & Heckklappendämpfer		Kraftstofftank	

Warnhinweise

Nach dem Abklemmen der Batterie 30 Sekunden warten.

SUBARU: Forester
 Typ: SJ
 Karosserieversion ab MJ 2013









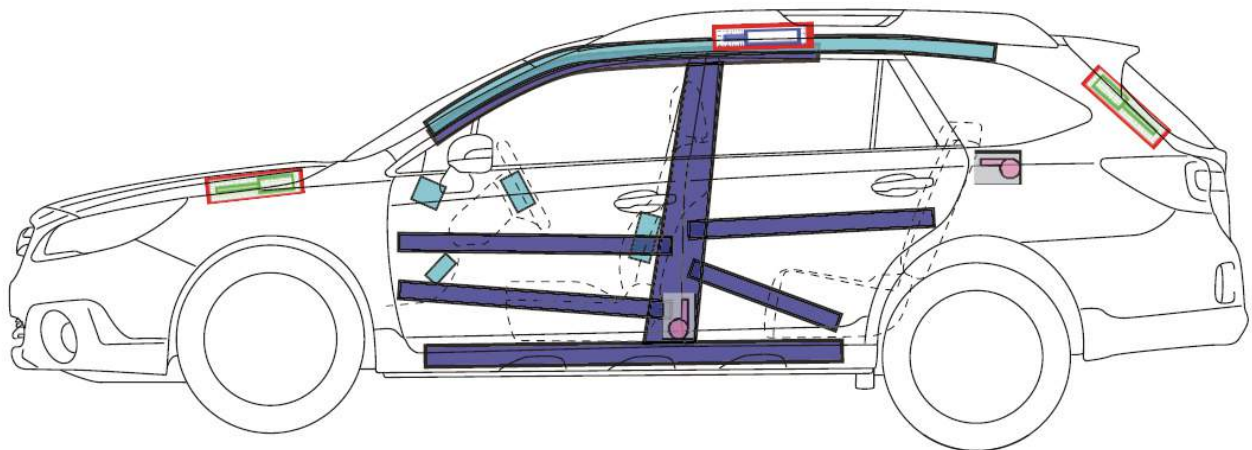
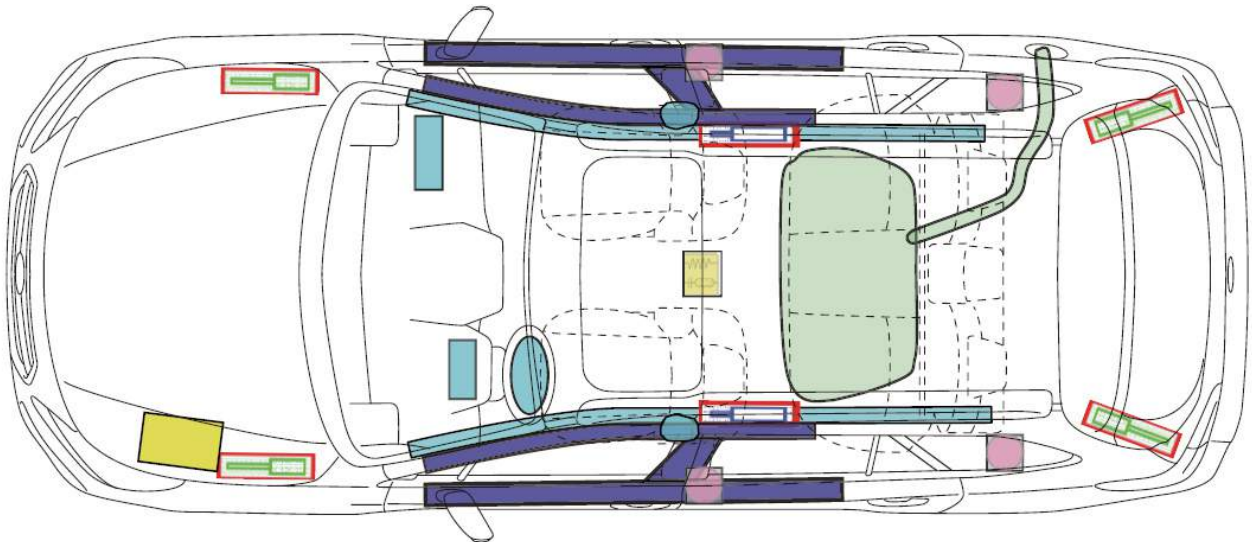

Airbag Modul		Karosserieverstärkungen		Airbag Kontrollmodul	
Fensterairbag Gasgenerator				Batterie	
Gurtstraffer		Hauben & Heckklappendämpfer		Kraftstofftank	

Warnhinweise

Nach dem Abklemmen der Batterie 30 Sekunden warten.

SUBARU: Outback Benzin & Diesel
 Typ: BSD/BS9
 Karosserievariante ab MJ 2015









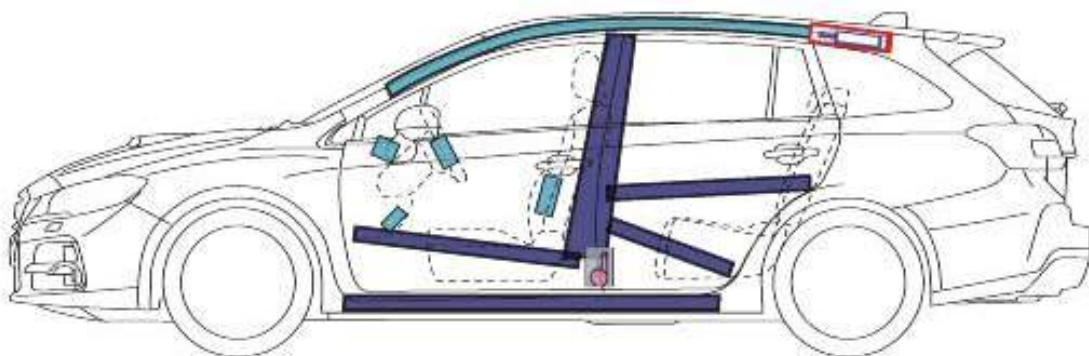
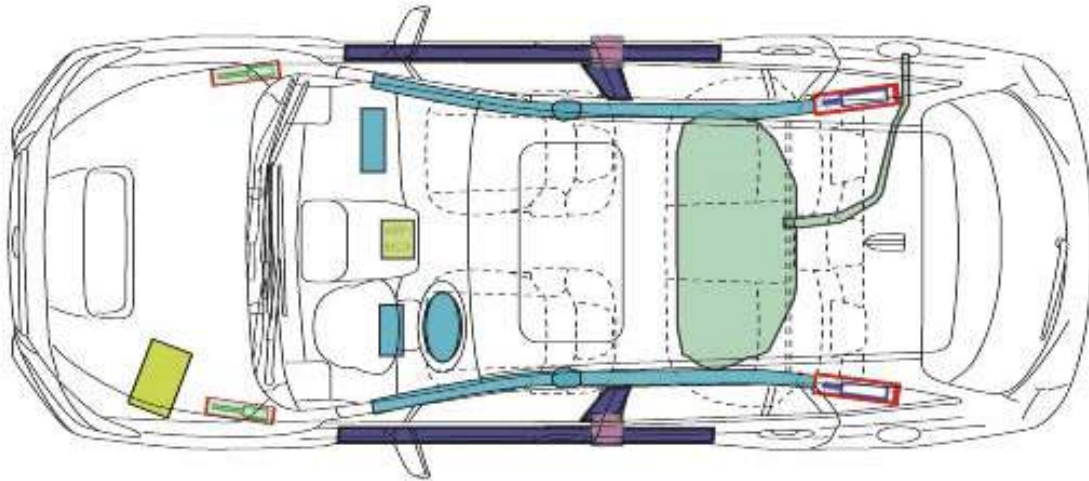

Airbag Modul		Karosserieverstärkung		Airbag Kontrollmodul	
Fensterairbag Gasgenerator				Batterie	
Gurtstraffer		Hauben & Heckklappendämpfer		Kraftstofftank	

Warnhinweise

Nach dem Abklemmen der Batterie 30 Sekunden warten.

SUBARU: Levorg
 Typ: VM
 Karosserievariante ab MJ 2016









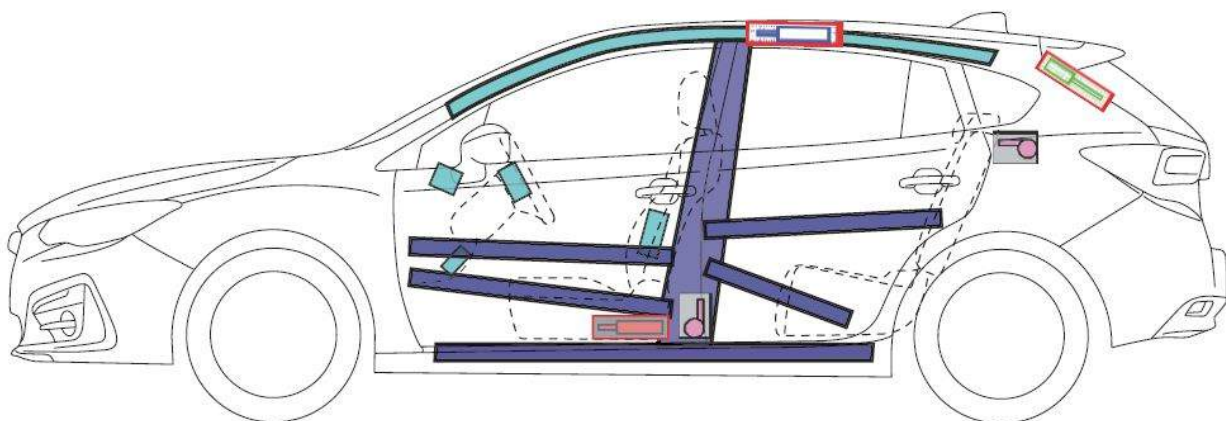
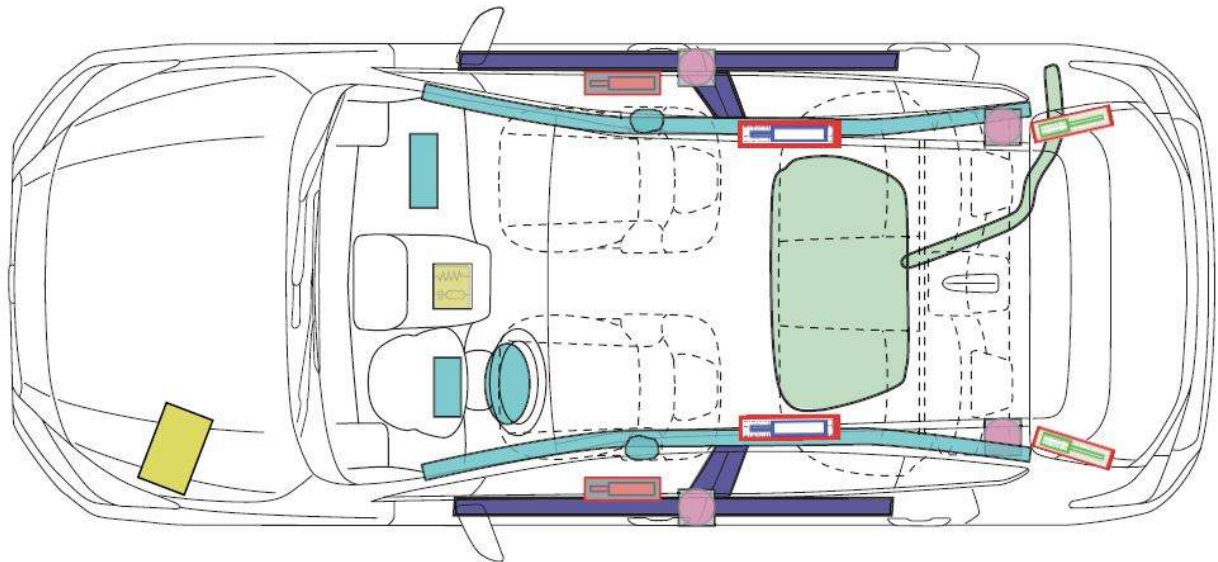

Airbag Modul		Karosserieverstärkung		Airbag Kontrollmodul	
Fensterairbag Gasgenerator				Batterie	
Gurtstraffer		Hauben & Heckklappendämpfer		Kraftstofftank	

Warnhinweise

Nach dem Abklemmen der Batterie 30 Sekunden warten.

SUBARU: Impreza / XV
 Typ: G5
 Karosserieversion ab MJ 2018



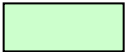







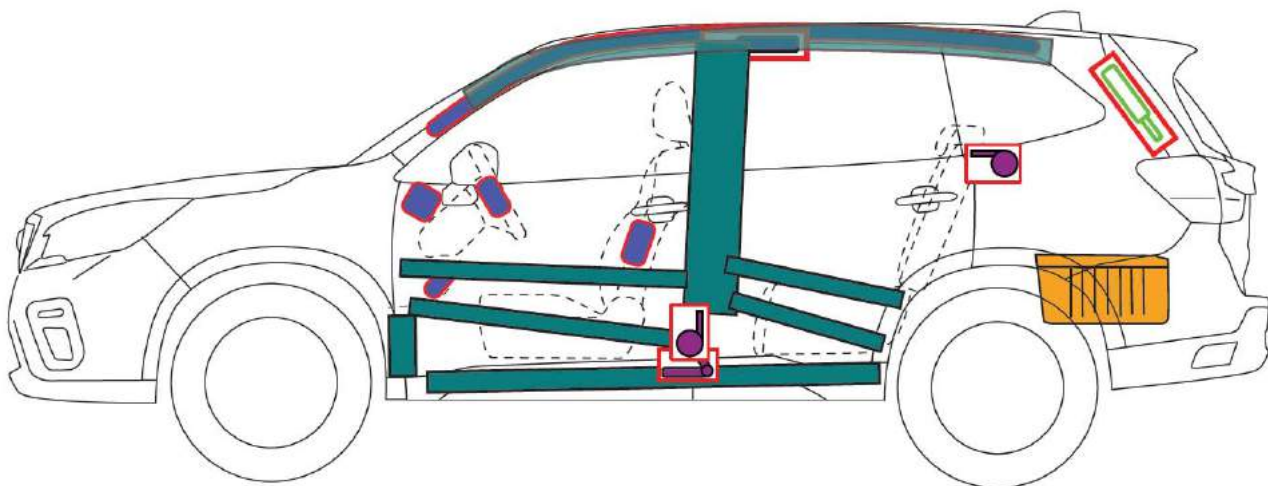
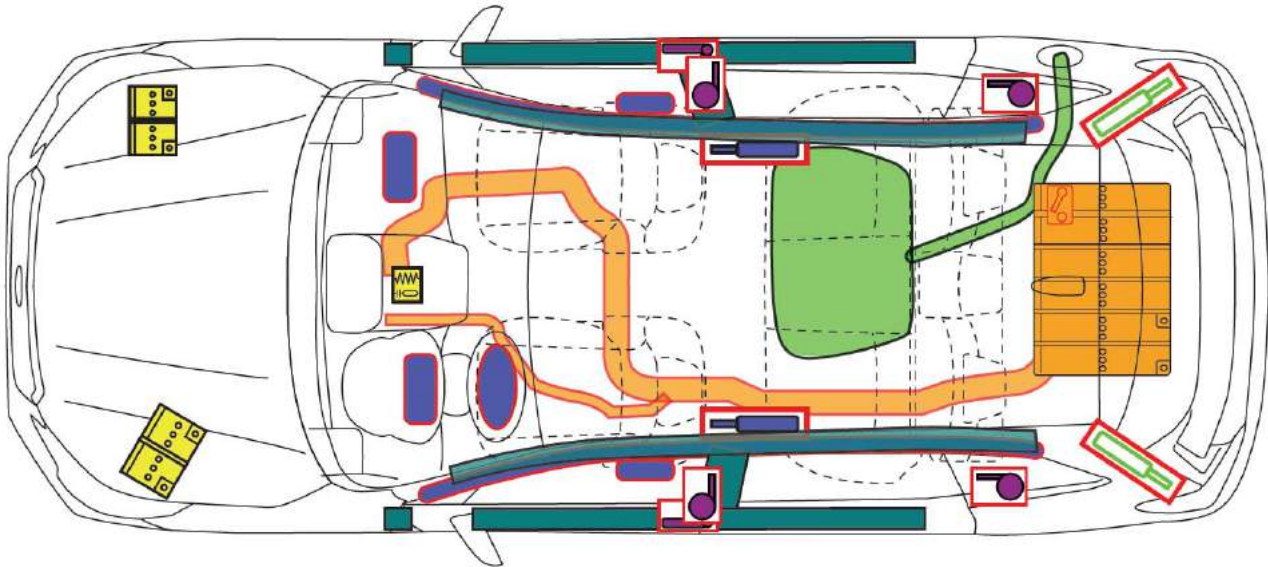

Airbag Modul		Karosserieverstärkungen		Airbag Kontrollmodul	
Fensterairbag Gasgenerator				Batterie	
Gurtstraffer		Hauben & Heckklappendämpfer		Kraftstofftank	

Warnhinweise

Nach dem Abklemmen der Batterie 30 Sekunden warten.

SUBARU: Forester
 Typ: S5
 Karosserievariante ab MJ 2020











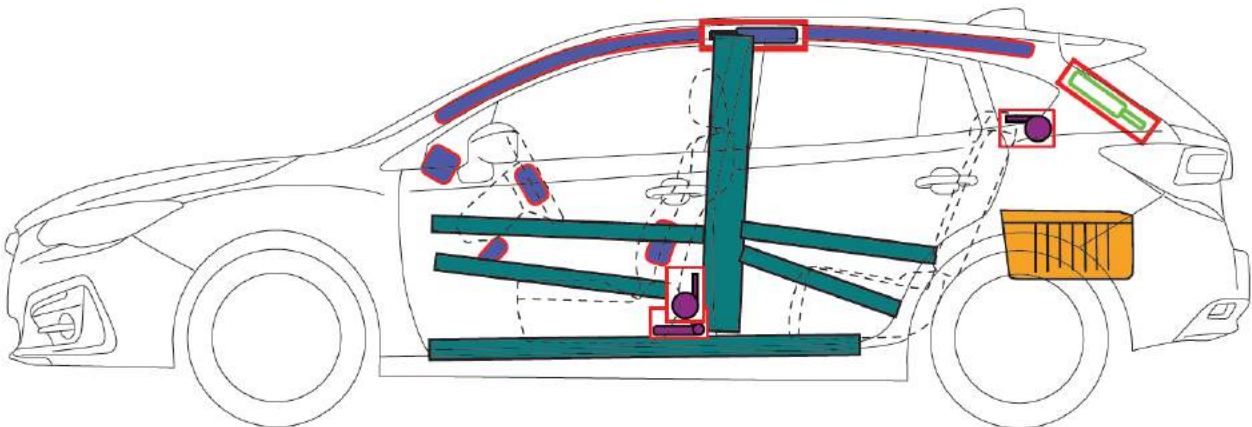
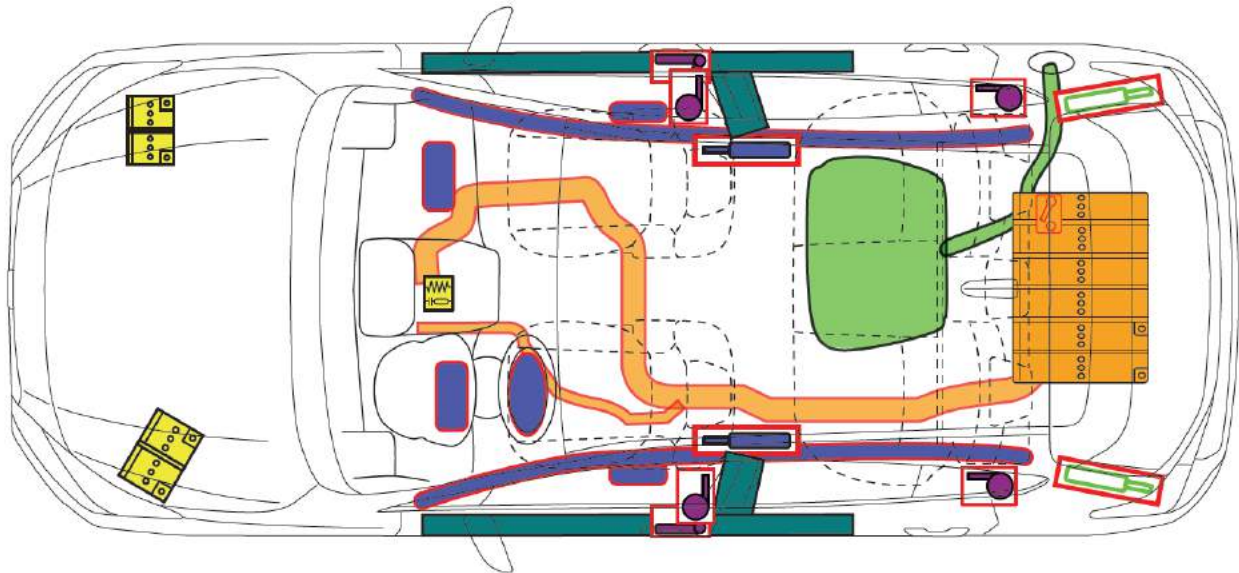

Airbag Modul		Karosserieverstärkung		Airbag Kontrollmodul	
Fensterairbag Gasgenerator		Hybridsystem		Batterie	
Gurtstraffer		Hauben & Heckklappendämpfer		Kraftstofftank	

Warnhinweise

Nach dem Abklemmen der Batterie 30 Sekunden warten.

SUBARU: Impreza
 Typ: G5
 Karosserievariante ab MJ 2020











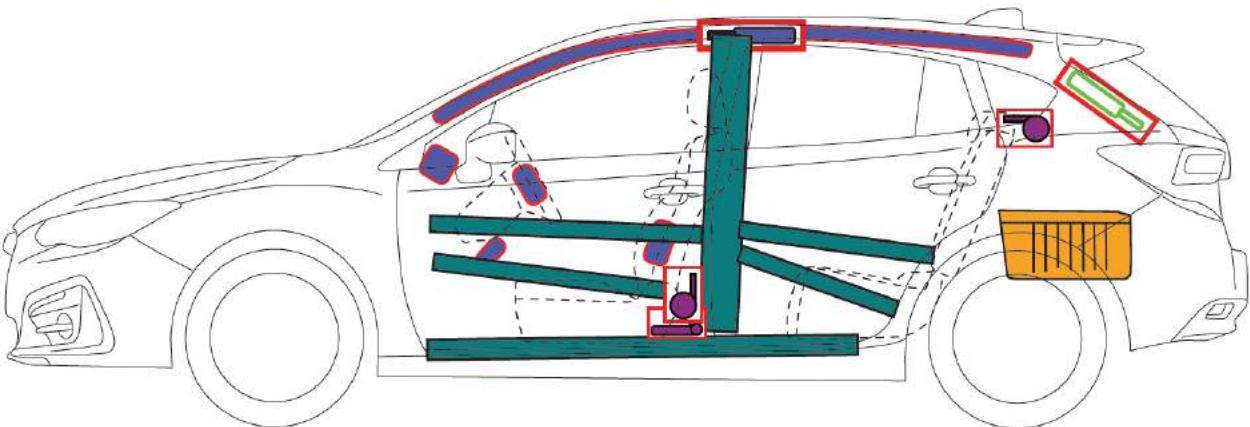
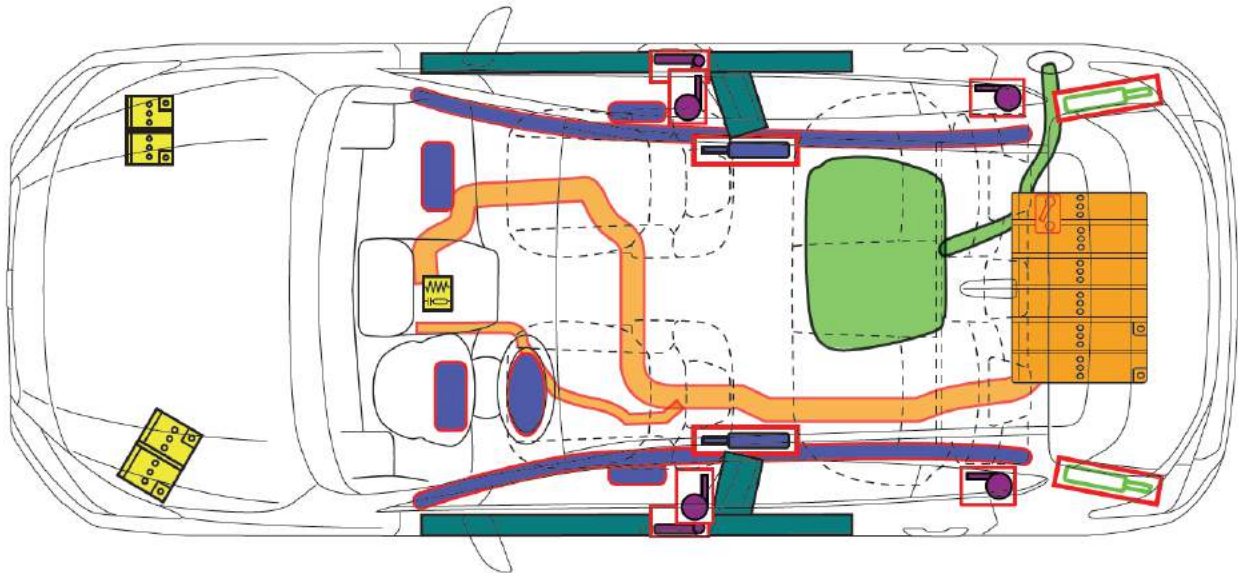

Airbag Modul		Karosserieverstärkung		Airbag Kontrollmodul	
Fensterairbag Gasgenerator		Hybridsystem		Batterie	
Gurtstraffer		Hauben & Heckklappendämpfer		Kraftstofftank	

Warnhinweise

Nach dem Abklemmen der Batterie 30 Sekunden warten.

SUBARU: SUBARU XV
 Typ: G5
 Karosserievariante ab MJ 2020



Airbag Modul		Karosserieverstärkung		Airbag Kontrollmodul	
Fensterairbag Gasgenerator		Hybridsystem		Batterie	
Gurtstraffer		Hauben & Heckklappendämpfer		Kraftstofftank	

Warnhinweise

Nach dem Abklemmen der Batterie 30 Sekunden warten.

SUBARU: Outback
 Typ: B7/BT9
 Karosserievariante ab MJ 2021

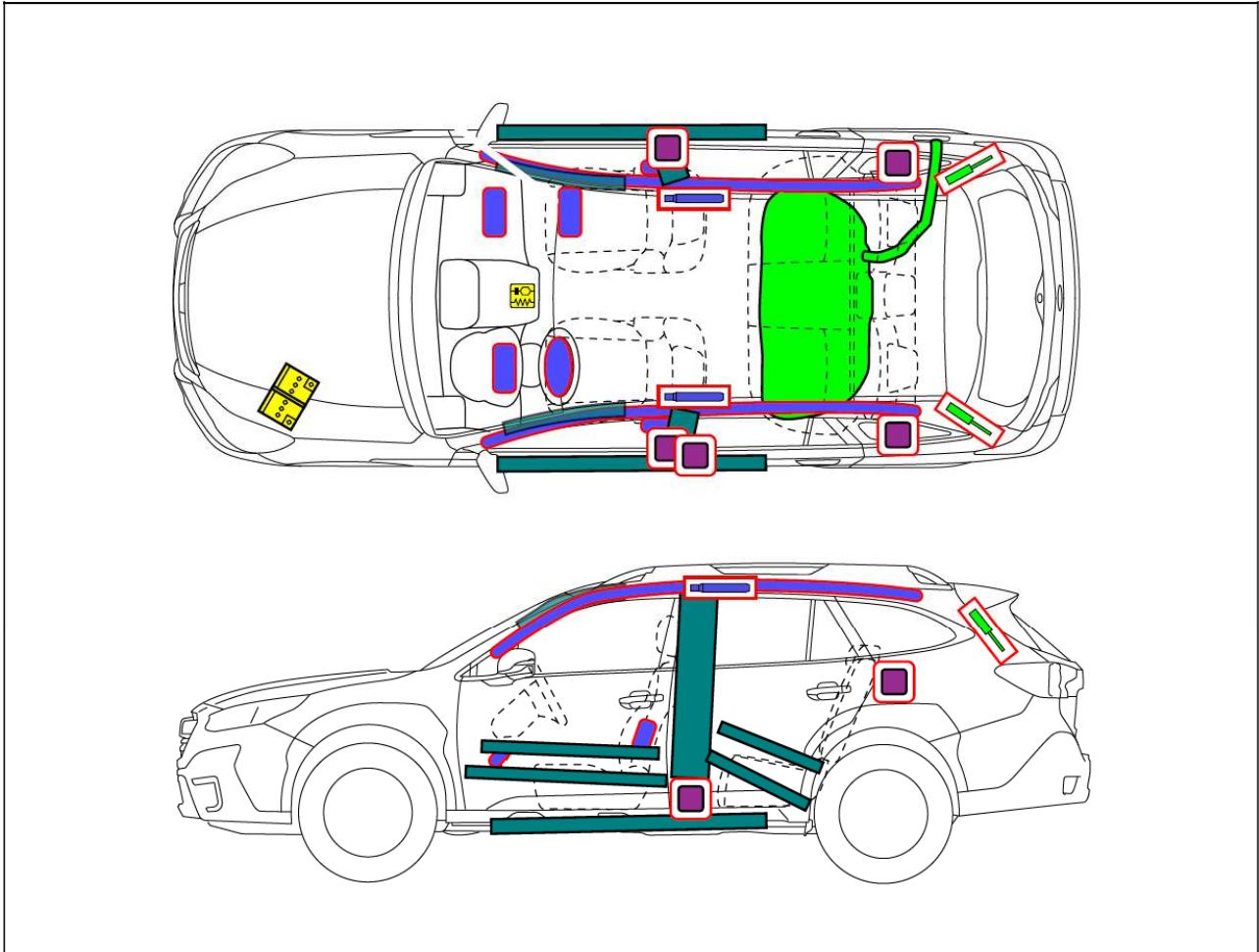

	Airbag		Gasgenerator		Gurtstraffer		SRS Steuergerät		Aktives Fußgänger-schutzsystem
	Automatisches Überroll-Schutzsystem		Gasdruckdämpfer / vorgespannte Feder		Karosserie-Verstärkung		Sensibler Bereich		
	Niedervolt-Batterie		Niedervolt-Kondensator		Treibstofftank		Gastank		Sicherheitsventil

Warnhinweise

Nach dem Abklemmen der Batterie 30 Sekunden warten.



SUBARU SOLTERRA
 Typ: EAM1S(M)
 Karosserievariante ab MJ 2023



RETTUNGSKARTE

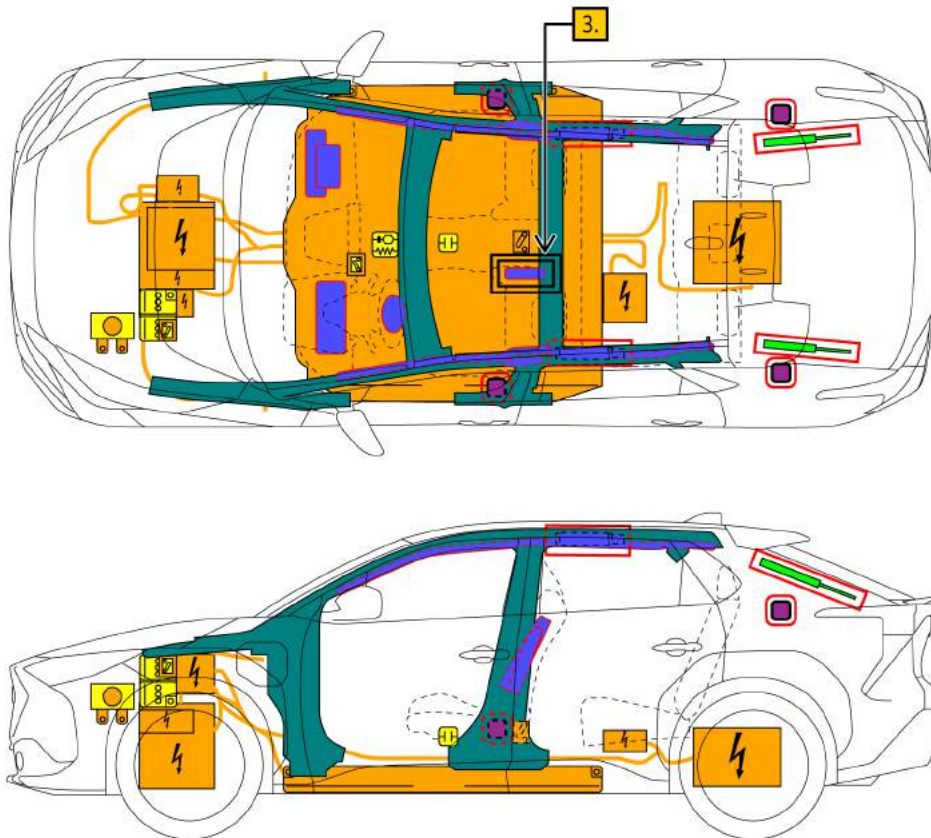

	Airbag		Gasdruck Patrone Airbag		Gurtstraffer		Airbag Steuergerät		Fußgänger- Schutzsystem
	Automatisches Überschlag- schutz System		Gasdruckdämpfer		Hochfeste Stahlteile		Zone requiring special attention		
	Batterie 12V		Niedrigvolt Kondensator		Kraftstofftank		Gastank		Sicherheitsventil
	Hochvoltbatterie		Hochvolt Kabelverbindung		Hochvolt- abschaltung		Sicherung zur Abschaltung Hochvoltsystems		Hochvolt- Kondensator
	Niederspannungs- einheit zur Abschaltung von Hochvolt								
	ID No.	Version No.		Version date		Page			
	SOLTERRA15	01		03 / 2022		1 / 4			

1. Identifikation

■ Positionen der Labels

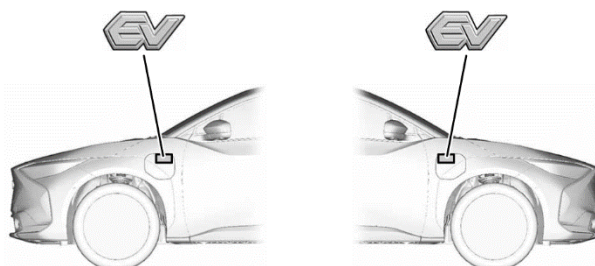
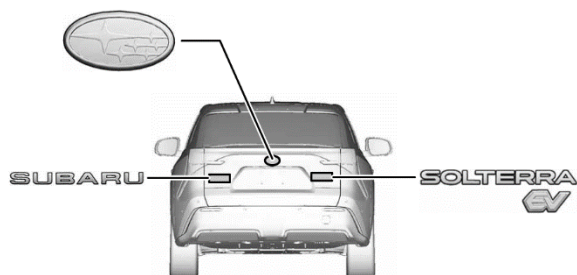

■ Energiequelle: Lithium-ionen Batterie



2. Immobilisierung / Stabilisierung / Anheben

■ Vollständiges Abschalten des Fahrzeugs

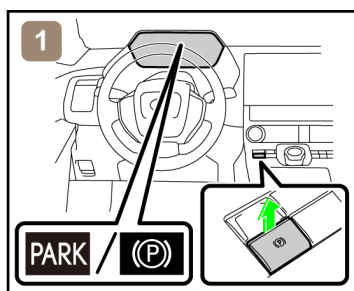

1) Vollständig Anhalten und Parkbremse aktivieren

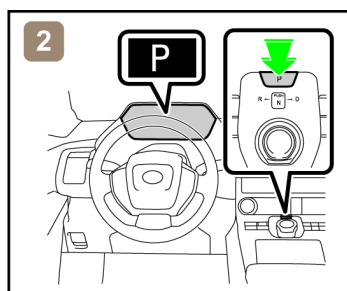

2) Position "P" wählen.

■ Stabilisierung-Anhebepunkte

Mit einer 4 Punkt Hebebühne an den markierten Punkten anheben. Vorsicht auf beschädigungsfreie Batterieachten

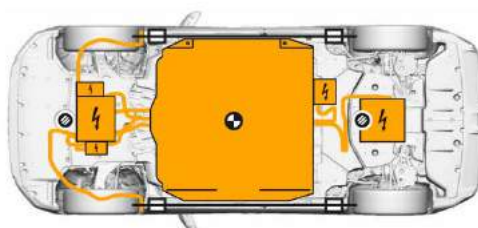

Versätkte Anhebepunkte



Standard-Hebebühne



Fahrzeugmittelpunkt



Legen Sie keine Untergestelle wie Holzklötze oder Lufthebekissen unter die Hochspannungskabel. Dies kann zu einem Brand oder Stromschlag führen.

3. Gefahrenvermeidung / Sicherheitshinweise

- Wenn eines der folgenden Systeme betrieben werden muss, nutzen Sie es, **BEVOR** Sie die Batterie abklemmen.

Zentralverriegelung
Heckklappe

Fensterheber
Elektrische Parkbremse

Elektrische Sitzverstellung
Elektronischer Wählhebel



Bei abgeklemmter 12-V-Batterie können elektrische Komponenten nicht betrieben werden.

- angegebenes Verfahren oder Alternative durchführen, um das Fahrzeug vollständig abzuschalten.

<Vorgehensweise>

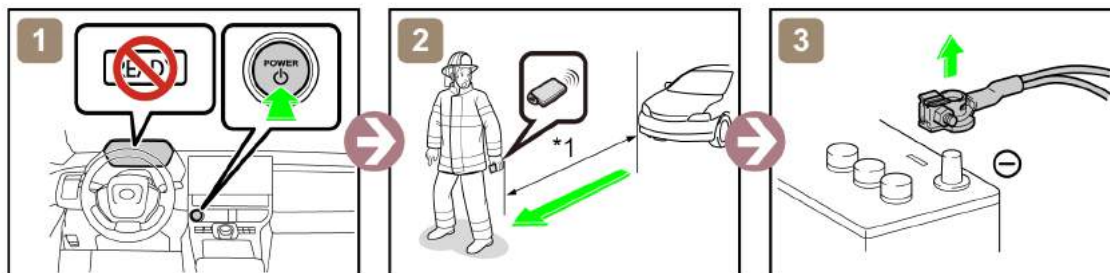
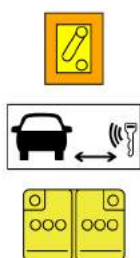

*1: 5 m oder mehr

Alternativethode>

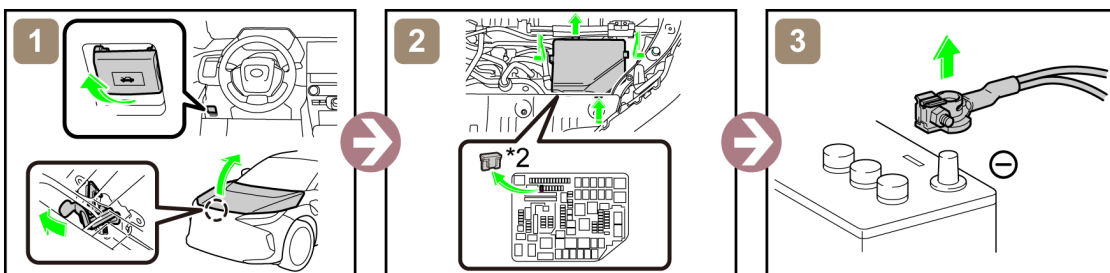
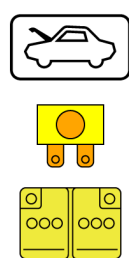

*2: Hauptsicherungskasten (30 A GREEN)

- Zugang zur 12 V Batterie

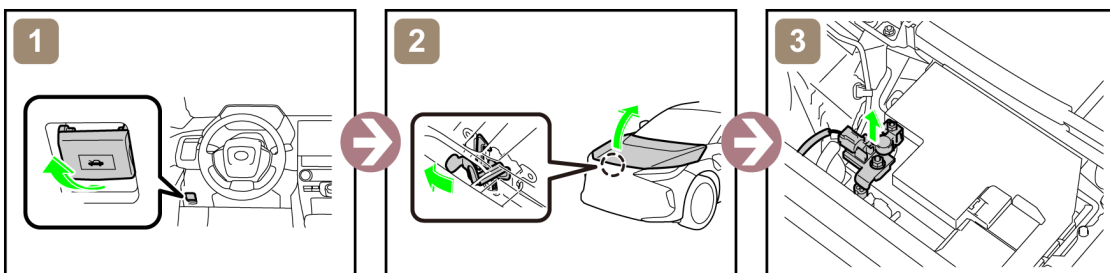
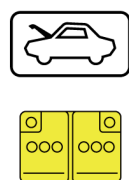

4. Zugang zu den Insassen

- Glasflächen

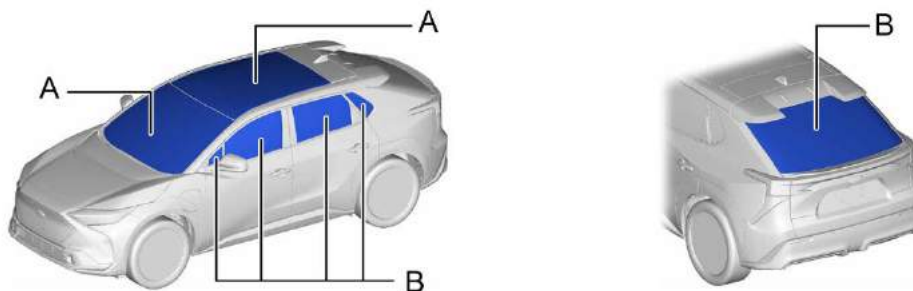

A	Zwei-Schicht Verglasung	B	Sicherheitsglas
---	-------------------------	---	-----------------

5. Energiesystem / Flüssigkeiten / Gase / Feststoffe



Hochvolt Li-Ionen Batterie



12 V Batterie



- Tragen Sie beim Umgang mit diesen Gegenständen immer geeignete persönliche Schutzausrüstung
- Unter keinen Umständen, einschließlich Feuer, die Abdeckung der Batteriebaugruppe beschädigen oder entfernen. Dies kann zu schweren Verletzungen oder zum Tod durch schwere Verbrennungen oder Stromschläge führen.

6. Im Falle eines Feuers



VERWENDEN SIE VIEL WASSER

Wenn es schwierig ist, reichlich Wasser auf die Hochspannungsbatterie aufzutragen, wird empfohlen, die Hochspannungsbatterie ausbrennen zu lassen.



WIEDERZÜNDUNG
MÖGLICH !



7. Im Falle von Untertauchen



Berühren Sie keine der Hochspannungskomponenten oder -kabel, einschließlich des Wartungssteckers, während das Fahrzeug unter Wasser ist. Dies kann zu einem Stromschlag führen. Arbeiten am Fahrzeug erst, nachdem das Fahrzeug aus dem Wasser gezogen wurde.

8. Abschleppen

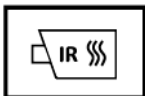
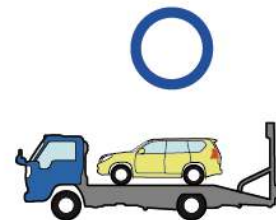
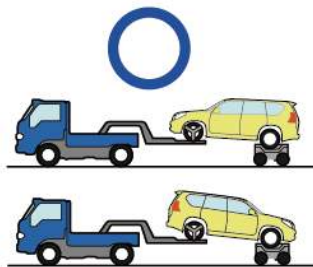
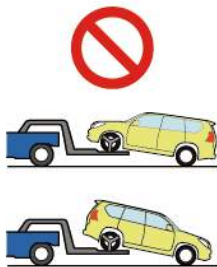

WIEDERZÜNDUNG
MÖGLICH !

Fahrzeug in sicherem Abstand (15 m oder mehr) zu anderen Fahrzeugen abstellen.

9. Wichtige zusätzliche Informationen

ID No.	Version No.	Version date	Page
SOLTERRA15	01	03 / 2022	4 / 4

1. Identifizierung/Erkennung

Position der Fahrzeugemblem

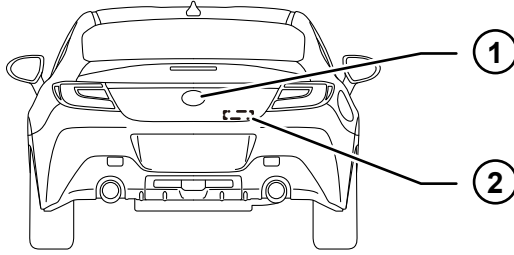

2. Immobilisieren/Stabilisieren/Anheben

Immobilisieren Sie das Fahrzeug vollständig

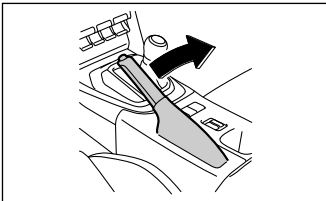

1. Zum Einstellen der Feststellbremse das Bremspedal fest drücken und gedrückt halten, bis der Feststellbremshebel vollständig hochgezogen ist.

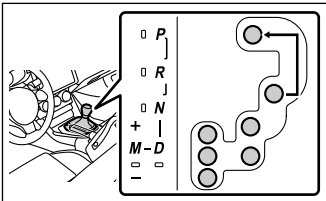

2. Den Wählhebel in Parkposition bringen. (Modell mit Automatikgetriebe)

Stabilisierung-Hebepunkt

An 4 Stellen direkt unter den Front- und Seitenschwellern stützen.

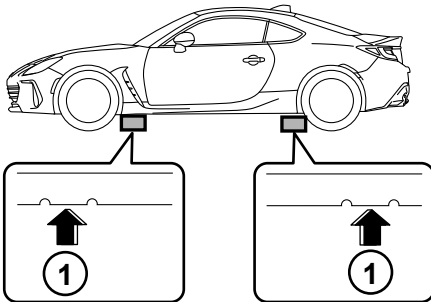

1 Stützstellen

3. Direkte Gefahren ausschalten/Sicherheitsbestimmungen

Wenn eines der folgenden Systeme bedient werden muss, tun Sie dies erst, BEVOR Sie die Batterie abklemmen.

Zentralverriegelung

Elektrischer Fensterheber



Sobald die 12-Volt-Hilfsbatterie getrennt ist, funktionieren die elektrischen Verstellungen nicht mehr.

Führen Sie das Haupt- oder Alternativverfahren durch, um das Fahrzeug vollständig abzuschalten.

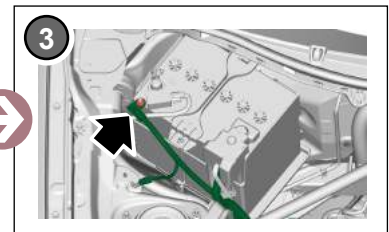
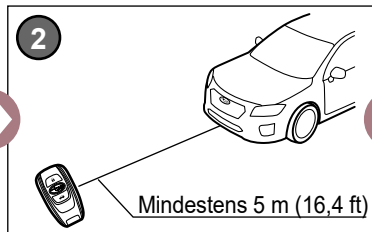
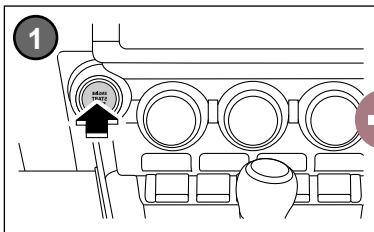
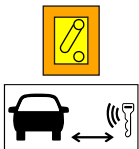

Zugriff auf Niedervolt-Batterie

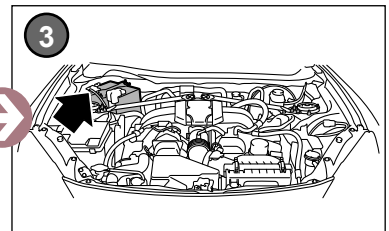
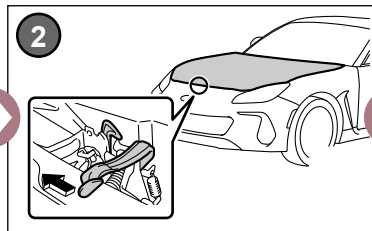
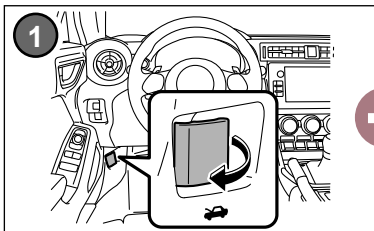
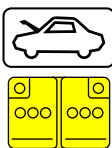

4. Zugang zu den Insassen

■ Fensterscheiben

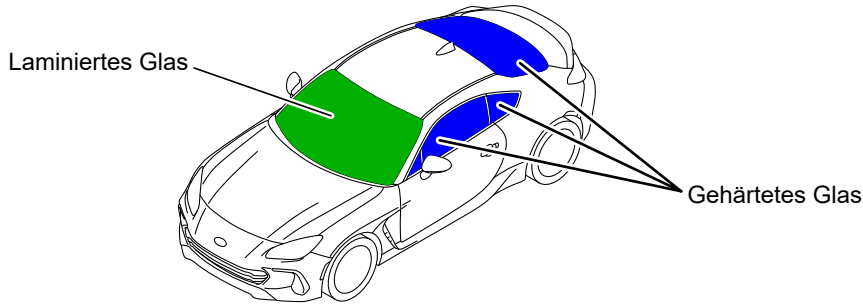

■ Sitzverstellung

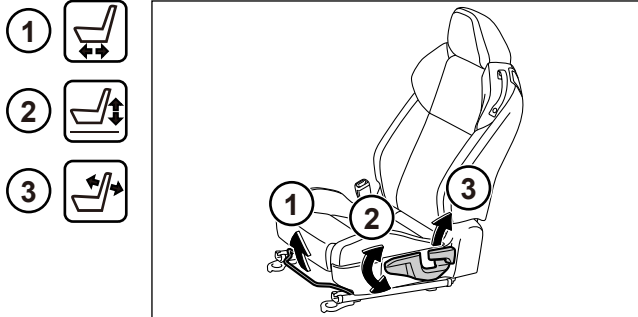

■ Einstellung der Lenksäule

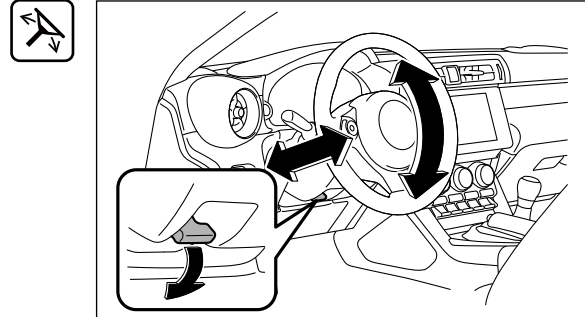

■ Hochfestigkeitsstahl in Karosserie

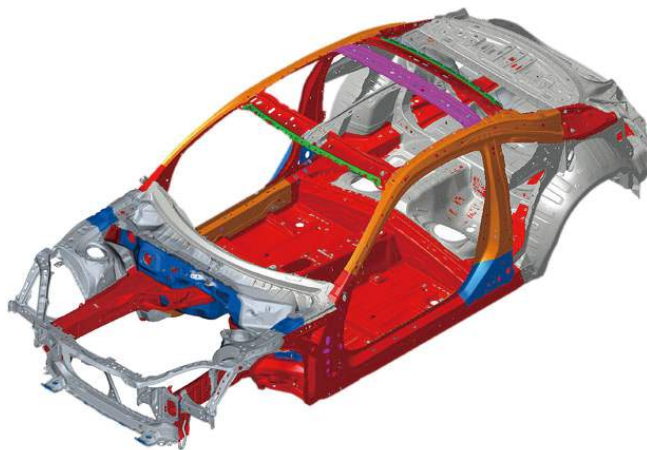

	Aluminiummaterial
	270 MPa (2.753 kgf /cm ² , 39.150 psi)
	400 bis 440 MPa (4.079 bis 4.487 kgf /cm ² , 57.999 bis 63.799 psi)
	590 MPa (6.016 kgf /cm ² , 85.549 psi)
	980 MPa (9.993 kgf /cm ² , 140.299 psi)
	1.500 MPa (15.295 kgf /cm ² , 217.498 psi)

■ Türschlösser

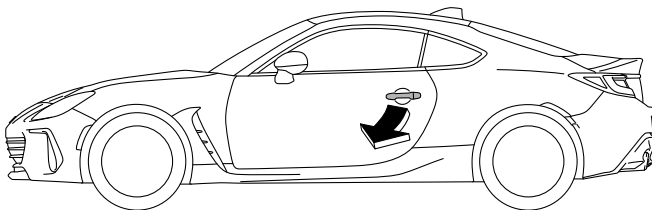

5. Gespeicherte Energie/Flüssigkeiten/Gase/Feststoffe

	12 V	
	50 L	
	HFC-134a : 0,39 kg (0,86 lb) HFO-1234yf : 0,40 kg (0,88 lb)	

6. Im Brandfall



7. Im Falle des Untertauchens

Holen Sie das Fahrzeug wenn möglich aus dem Wasser und fahren Sie mit dem Deaktivierungsverfahren für dieses Fahrzeug fort (siehe Kapitel 3).

8. Abschleppen/Transport/Lagerung

O = OK

⊘ = NG

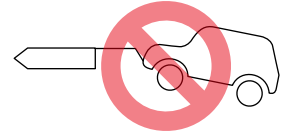
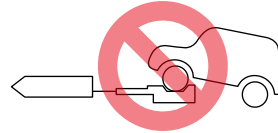
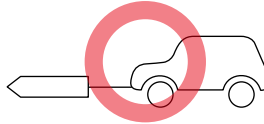
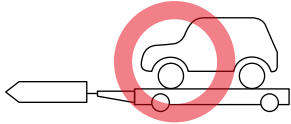

Weniger als 30 km/h (19 MPH)

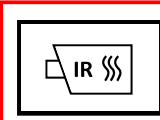

**WIEDERENTZÜNDUNG
MÖGLICH!**

Stellen Sie das Fahrzeug mit ausreichend Sicherheitsabstand zu anderen Fahrzeugen ab.

Position des vorderen Hakens



Position des hinteren Hakens



Position der Werkzeuge (Typ A)

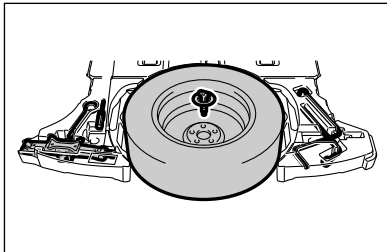

Position der Werkzeuge (Typ B)

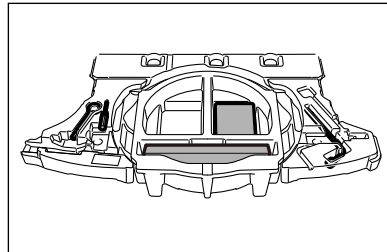

9. Wichtige zusätzliche Informationen

10. Erläuterung der verwendeten Piktogramme

	Fahrzeug mit flüssigen Kraftstoffen der Kl. 2		Niedervolt-Batterie		Treibstofftank
	Regelung der Lenkradneigung		Sitzhöhenverstellung		Motorhaube
	Sitzlehnenverstellung		Horizontale Sitzverstellung		IR-Wärmebildkamera benutzen
	Smart-Schlüssel entfernen		Klimaanlage		Gefahr
	Gas unter Druck		Explosiv		Entzündbar
	Korrosiv		Gesundheitsschädlich		

ID Nr.

JF1-T4600GG

Versions-Nr.

01

Versions-Datum

07/2022

Seite

4 / 4